



SPECSHEET ZOOVER 120



1. Properties of the basic material	P2
1.1. Weighted sound absorption coefficient	
1.2. Fire classification	
2. Equivalent sound absorption area per object (A_{obj}) of ZOOVER 120	
2.1. At 0,5m from ceiling	P3
2.2. At 1m from ceiling	P4
3. Official report	P5



1. Properties of the basic material

1.1. Weighted sound absorption coefficient
according to: **to be confirmed**

1.2. Fire classification

According to: **to be confirmed**

2. Equivalent sound absorption area per object (A_{obj}) of ZOOVER 120

Frequency-dependent value of the sound absorption coefficient which is based on measurements on one-third-octave bands in accordance with ISO 354 and which is calculated in octave bands in accordance with the standard ISO 11654:1997.

The equivalent sound absorption area for each octave band i , is calculated from the arithmetic mean value of the three one-third octave sound absorption coefficients within the octave. In line with the standard ISO 354, the mean value is calculated to the first decimal.



2.1. At 0,5m from ceiling

EN ISO 354:2003

Acoustics - Measurement of sound absorption in a reverberation room

EN ISO 11654:1997

Acoustics - Sound absorbers for use in buildings - Rating of sound absorption

Identification number of test element: 14

Test date: 26/05/2021

Reverberation room:

V = 298,3 m³

S_{tot} = 279,9 m²

Room conditions during measurements:

Empty room

With testelement

Temperature:

T = 19,6

19,2 °C

Atmospheric pressure:

p = 100,9

101,0 kPa

Relative humidity :

h_r = 55

56,7 %

Type of test element:

Discrete object

Construction characteristics:

Number of tested objects

3

Number of location setups in the reverberation room

1

Test setup:

3 panels on a wooden frame
Height of the panels = 50 cm
Distance between each panel = 2 m

f(Hz)	T ₁ (s)	T ₂ (s)	A _{obj} [m ²]	δ ₉₅ (A _{obj})
50				
63				
80				
100	10,65	8,57	0,4	0,06
125	9,01	7,48	0,4	0,07
160	9,31	6,70	0,7	0,07
200	9,62	6,61	0,8	0,06
250	9,73	6,34	0,9	0,06
315	9,49	6,43	0,8	0,05
400	9,09	6,12	0,9	0,05
500	9,00	5,78	1,0	0,05
630	9,47	6,11	0,9	0,04
800	9,31	5,93	1,0	0,04
1000	9,28	5,86	1,0	0,03
1250	8,48	5,42	1,1	0,03
1600	7,50	4,90	1,1	0,03
2000	6,66	4,43	1,2	0,03
2500	5,61	3,84	1,3	0,04
3150	4,62	3,27	1,4	0,04
4000	3,58	2,68	1,5	0,05
5000	2,87	2,26	1,6	0,07

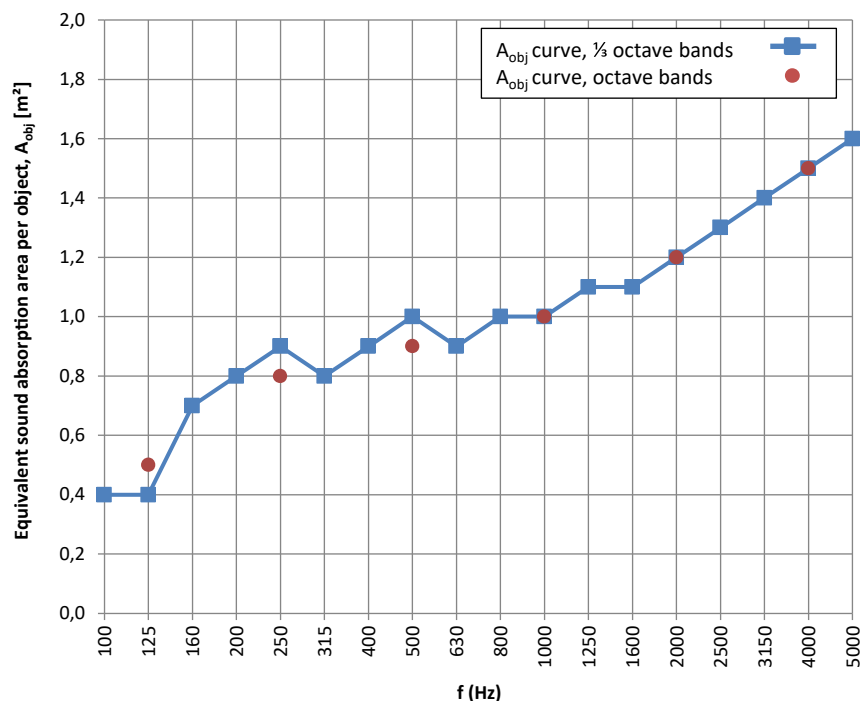

Note: an individual object is not evaluated according to ISO 11654 (α_w and class)

Requested by: Deltalight, Muizelstraat 2, B-8560 Wevelgem (Moorsele)

TESTELEMET: (for details see Annex 2)



2.2. At 1m from ceiling

EN ISO 354:2003

Acoustics - Measurement of sound absorption in a reverberation room

EN ISO 11654:1997

Acoustics - Sound absorbers for use in buildings - Rating of sound absorption

Identification number of test element: **15**

Test date: 26/05/2021

Reverberation room:

V = 298,3 m³

S_{tot} = 279,9 m²

Room conditions during measurements:

Temperature:

T = 19,6 °C
Empty room

With testelement

19,2 °C

Atmospheric pressure:

p = 100,9 kPa

101,0 kPa

Relative humidity :

h_r = 55 %

56,7 %

Type of test element:

Discrete object

Construction characteristics:

Number of tested objects

3

Number of location setups in the reverberation room

1

Test setup:

3 panels on a wooden frame
Height of the panels = 100 cm
Distance between each panel = 2 m

f(Hz)	T ₁ (s)	T ₂ (s)	A _{obj} [m ²]	δ95 (Aobj)
50				
63				
80				
100	10,65	9,39	0,2	0,06
125	9,01	8,03	0,2	0,07
160	9,31	7,68	0,4	0,06
200	9,62	7,33	0,5	0,05
250	9,73	6,65	0,8	0,05
315	9,49	6,34	0,8	0,05
400	9,09	5,94	0,9	0,05
500	9,00	5,86	1,0	0,05
630	9,47	6,05	1,0	0,04
800	9,31	5,94	1,0	0,04
1000	9,28	5,75	1,1	0,03
1250	8,48	5,33	1,1	0,03
1600	7,50	4,84	1,2	0,03
2000	6,66	4,33	1,3	0,04
2500	5,61	3,81	1,4	0,04
3150	4,62	3,26	1,5	0,05
4000	3,58	2,67	1,6	0,06
5000	2,87	2,23	1,6	0,07

f(Hz)	A _{obj} [m ²]
125	0,3
250	0,7
500	1,0
1000	1,1
2000	1,3
4000	1,6

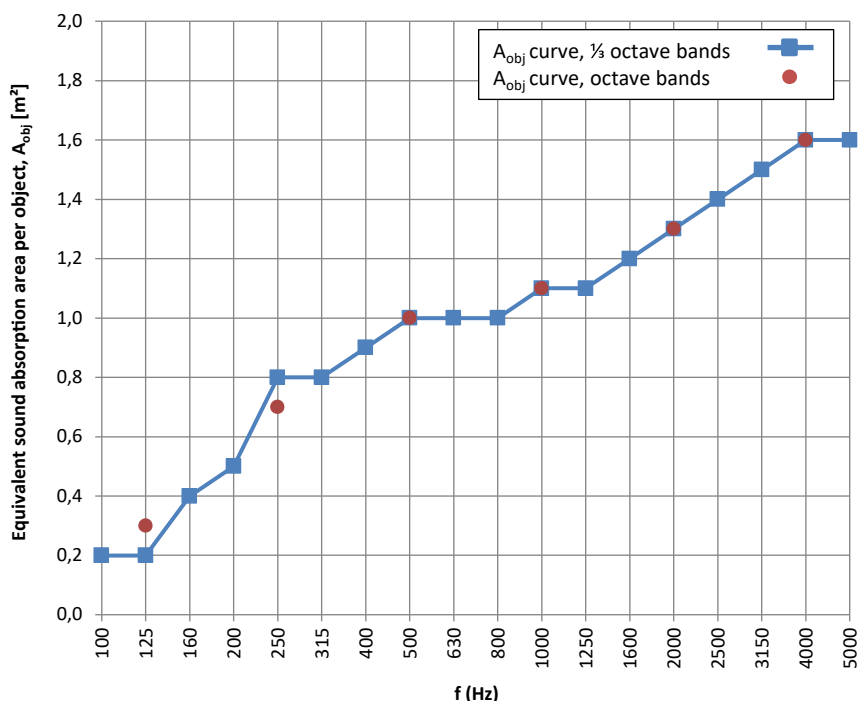

Note: an individual object is not evaluated according to ISO 11654 (α_w and class)

Requested by: Deltalight, Muizelstraat 2, B-8560 Wevelgem (Moorsele)

TESTELEMANT: (for details see Annex 2)

3. Official report



Daidalos Peutz bouwfysisch ingenieursbureau
Vital Decosterstraat 67A – bus 1
B-3000 Leuven
Belgium
VAT: BE 0454.276.239
www.daidalospeutz.be



N° 451-TEST
NBN EN ISO 17025:2017
EA MLA signatory

NOISE LAB
REPORT Number A-2021LAB-061-13-15-44342_E

Customer : Deltalight
Muizelstraat 2
B-8560 Wevelgem (Moorsele)
Belgium
Techsupport@deltalight.com

Contacts : **Client :** Deltalight
Noise lab : Gert-Jan Loobuyck

Tests : Measurement of sound absorption in the reverberation room

Product name : Zoover 120

Normative references:
NBN EN ISO 354:2003 **Acoustics - Measurement of sound absorption in a reverberation room**

NBN EN ISO 11654:1997 Acoustics - Sound absorbers for use in buildings - Rating of sound absorption
NBN ISO 9613-1:1996 Acoustics - Attenuation of sound during propagation outdoors -
part 1 : Calculation of the absorption of sound by the atmosphere
ISO 12999-2:2020 Acoustics - Determination and application of measurement uncertainties in building acoustics
Part 2: Sound absorption

To perform the above measurements, the laboratory of Daidalos Peutz is accredited by BELAC, "The Belgian Accreditation Body", under the certificate nr N°451-TEST. The activities covered by this accreditation certificate are covered by the EA MLA.
BELAC is a signatory of all existing multilateral agreements and recognition agreements of International Laboratory Accreditation Cooperation (ILAC).
In this way, reports issued by BELAC accredited bodies are internationally accredited.

Date and reference of the request:	9/04/2021	2021LAB-061
Date of receipt of the specimen(s):	26/05/2021	
Date of construction:	26/05/2021	till 26/05/2021
Date of tests:	26/05/2021	till 26/05/2021
Date of preparation of the report:	7/06/2021	

This test report together with its annexes contains : 14 pages and must be multiplied only in its entirety

Technical Manager,

Paul Mees

Laboratory Worker,

Gert-Jan Loobuyck



Daidalos Peutz bouwfysisch ingenieursbureau
Vital Decosterstraat 67A – bus 1
B-3000 Leuven
Belgium
VAT: BE 0454.276.239
www.daidalospeutz.be



N° 451-TEST
NBN EN ISO 17025:2017
EA MLA signatory

NOISE LAB
REPORT Number A-2021LAB-061-13-15-44342_E

MEASURING EQUIPMENT

Signal

Brüel & Kjaer - 4292 : Omni Power Sound Source

Microphone system:

Brüel & Kjaer - 4189-L-001 : 1/2" free field microphone prepolarized, inclusive 2669L TEDS
Brüel & Kjaer - 4189 : 1/2" free field microphone, 6Hz to 20kHz, prepolarized
Brüel & Kjaer - 2669 : 1/2" microphone preamplifier
Brüel & Kjaer - 4231 : Sound calibrator 94&114dB SPL-1000Hz, Fulfills IEC 60942(2003)Class1

Number of source positions:	2	(Different sound source positions at least 3m apart.
Number of microphone positions for each source position:	8	The measurements shall be made with different microphone positions
Number of measured decays curves:	3	which are at least 1,5m apart, 2m from any sound source and 1m from
Total number of measurements with different positions for microphone & source:	16	any room surface and the test specimen.)

Signal processing

Brüel & Kjaer - 2716C : Power amplifier
Brüel & Kjaer - 3050-A-6/0: Signal generator, 6-ch. Inputmodule LAN-XI
Brüel & Kjaer - 3160-A-042: Signal generator, 4/2-ch. Input/output module LAN-XI
Brüel & Kjaer : PULSE Labshop Version 13.5
A PC with all necessary software

Reverberation room

Dimensions of the room:	Total volume :	298,3 m ³
	Length:	9,99 m
	Width	4,97 m
	Height	5,98 m
	Volume door opening :	1,32 m ³
	Total area:	279,9 m ²
	$l_{max} = 12,65 \text{ m} < 1,9 V^{1/3}$	

In order to improve the diffusivity, the use of diffusers is necessary
The test specimen shall have a maximum area of 15,62 m², which depends on the room volume



Daidalos Peutz bouwfysisch ingenieursbureau
Vital Decosterstraat 67A – bus 1
B-3000 Leuven
Belgium
VAT: BE 0454.276.239
www.daidalospeutz.be



N° 451-TEST
NBN EN ISO 17025:2017
EA MLA signatory

NOISE LAB
REPORT Number A-2021LAB-061-13-15-44342_E

TEST METHOD

The tests were conducted in accordance with the provisions of the test method EN ISO354:2003. A detailed description of the test set up has been given in the figures of annex 1 of this report.

The measurement method can be simply described as follows:

Essence of the test is in measuring of the reverberation time in the empty reflecting room and in the same room with the test sample inside it. The sound-absorption properties of a material depend on how the material is mounted during the test. Annex B of ISO 354:2003 specifies several different standard mountings that shall be used during a test for sound absorption. Normally a test specimen is tested using only one of the specified mountings.

From these reverberation times, the equivalent sound absorption area of the test specimen, is calculated by using Sabine's equation. Measurement is carried out in ranges of 1/3 octave and interval from 100Hz to 5000Hz.

The equivalent sound absorption area of the empty reverberation room, A_1 , in square metres, shall be calculated using the formula (1) :

$$A_1 = 55,3 V / (c_1 T_1) - 4V m_1 \quad [m^2] \quad (1)$$

The equivalent sound absorption area of the reverberation room containing a test specimen, A_2 , in square metres, shall be calculated using the formula (2) :

$$A_2 = 55,3 V / (c_2 T_2) - 4V m_2 \quad [m^2] \quad (2)$$

The equivalent sound absorption area of the test specimen, A_T , in square metres, shall be calculated using the formula (3) :

$$A_T = A_2 - A_1 = 55,3 V (1/c_2 T_2 - 1/c_1 T_1) - 4V(m_2 - m_1) \quad [m^2] \quad (3)$$

The sound absorption coefficient of a plane absorber or a specified array of test objects shall be calculated using the formula (4):

$$\alpha_s = A_T / S \quad (4)$$

NOTE For discrete objects A_{obj} is used instead of α_s
For a specific array of objects the result is given as α_s

The equivalent sound absorption area of discrete absorbers or individual objects shall be calculated using the formula (5):

$$A_{obj} = A_T / n \quad \text{where } n \text{ is the number of tested objects} \quad (5)$$

- whereas:
- A_1 = The equivalent sound absorption area of the empty reverberation room in square metres
 - A_2 = The equivalent sound absorption area of the reverberation room containing a test specimen in square metres
 - V = volume, in cubic metres, of the empty reverberation room $[m^3]$
 - c_1, c_2 = the propagation speed of sound in air, in $[m/s]$, calculated using the formula
(in function of the temperature in the room during the test)
 $c = 331 + 0,6 t$ with $t =$ the air temperature in degrees Celsius for temperatures in the range of 15°C to 30°C
 - T_1 = the reverberation time, in seconds, of the empty reverberation room
 - T_2 = the reverberation time, in seconds, of the reverberation room after the test specimen has been introduced
 - m_1, m_2 = the power attenuation coefficient, in reciprocal metres, calculated according to ISO 9613-1:1993
 - A_T = The equivalent sound absorption area of the test specimen in square metres
 - S = the area, in square metres, covered by the test specimen
 - α_s = the sound absorption coefficient
 - A_{obj} = the equivalent sound absorption area per object
 - n = the number of tested discrete or individual objects

SPECIAL MEASUREMENT CONDITIONS

n/a



Daidalos Peutz bouwfysisch ingenieursbureau
Vital Decosterstraat 67A – bus 1
B-3000 Leuven
Belgium
VAT: BE 0454.276.239
www.daidalospeutz.be



N° 451-TEST
NBN EN ISO 17025:2017
EA MLA signatory

NOISE LAB
REPORT Number A-2021LAB-061-13-15-44342_E

RATING OF SOUND ABSORPTION

A_{obj} EQUIVALENT SOUND ABSORPTION AREA PER OBJECT

Frequency-dependent value of the sound absorption coefficient which is based on measurements on one-third-octave bands in accordance with ISO 354 and which is calculated in octave bands in accordance with the standard ISO 11654:1997.
The equivalent sound absorption area for each octave band i , is calculated from the arithmetic mean value of the three one-third octave sound absorption coefficients within the octave. In line with the standard ISO 354, the mean value is calculated to the first decimal.

α_w WEIGHTED SOUND ABSORPTION COEFFICIENT

The weighted sound absorption coefficient is determined as a single number value from the practical sound absorption coefficients from 250 Hz to 4000 Hz. The practical sound absorption coefficient is calculated according to ISO 11654:1997.
Single-number frequency-independent value which equals the value of the reference curve at 500 Hz after shifting is as specified in the standard ISO 11654:1997.

But an individual object is NOT evaluated with the standard ISO 11654, both in terms of the single-number value and the absorption class.

Test results related to tested object only. The test results should not be considered as material constants, the absorption depends not only on the material itself. The method of construction, the size of the material surface and its place in the room, affect the sound absorption characteristics of the test element.

ACCURACY

The accuracy of the absorption coefficients as calculated can be expressed in terms of repeatability of measured reverberation times (tests within one laboratory) and reproducibility (between various laboratories)

The relative standard deviation of the reverberation time T_{20} , evaluated over a 20dB decay range, can be estimated by the following formula (see 8.2.2. van ISO 354:2003)

These relative standard deviations of the reverberation time T_{20} were calculated and illustrated in annex 1.

The reproducibility of absorption coefficient measurement is still under investigation

The specific value of uncertainty is available on request



Daidalos Peutz bouwfysisch ingenieursbureau
Vital Decosterstraat 67A – bus 1
B-3000 Leuven
Belgium
VAT: BE 0454.276.239
www.daidalospeutz.be



N° 451-TEST
NBN EN ISO 17025:2017
EA MLA signatory

NOISE LAB
REPORT Number A-2021LAB-061-13-15-44342_E

1. A_{obj} Zoover 120 at 5cm height

EQUIVALENT SOUND ABSORPTION AREA PER OBJECT

EN ISO 354:2003 Acoustics - Measurement of sound absorption in a reverberation room
EN ISO 11654:1997 Acoustics - Sound absorbers for use in buildings - Rating of sound absorption

Identification number of test element: **13**

Test date: 26/05/2021

Reverberation room: V = 298,3 m³ S_{tot} = 279,9 m²
Room conditions during measurements: Empty room With testelement
Temperature: T = 19,6 °C
Atmospheric pressure: p = 100,9 kPa
Relative humidity: h_r = 55 %

Type of test element: **Discrete object**

Construction characteristics:
Number of tested objects: 3
Number of location setups in the reverberation room: 1

Test setup:
3 panels on wooden blocks
Height of the panels = 5 cm
Distance between each panel = 2 m

f(Hz)	T ₁ (s)	T ₂ (s)	A _{obj} [m ²]	δ ₉₅ (A _{obj})
50				
63				
80				
100	10,65	9,84	0,1	0,06
125	9,01	8,43	0,1	0,06
160	9,31	7,84	0,3	0,06
200	9,62	7,19	0,6	0,06
250	9,73	6,11	1,0	0,06
315	9,49	5,89	1,0	0,06
400	9,09	5,72	1,0	0,05
500	9,00	5,44	1,2	0,05
630	9,47	5,58	1,2	0,04
800	9,31	5,69	1,1	0,04
1000	9,28	5,78	1,1	0,03
1250	8,48	5,53	1,0	0,03
1600	7,50	5,09	1,0	0,03
2000	6,66	4,65	1,1	0,03
2500	5,61	4,04	1,1	0,04
3150	4,62	3,47	1,2	0,04
4000	3,58	2,83	1,2	0,05
5000	2,87	2,35	1,3	0,06

f(Hz)	A _{obj} [m ²]
125	0,2
250	0,9
500	1,1
1000	1,1
2000	1,1
4000	1,2

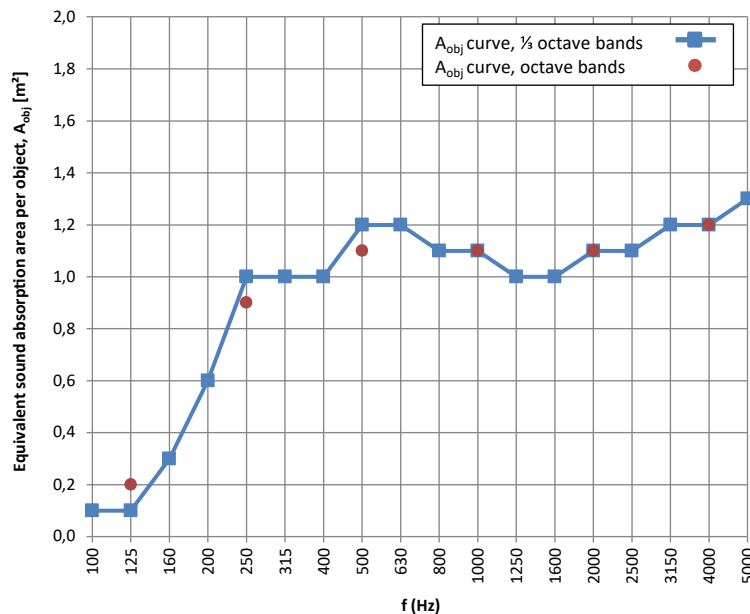

Note: an individual object is not evaluated according to ISO 11654 (α_w and class)

Requested by: Deltalight, Muizelstraat 2, B-8560 Wevelgem (Moorsele)
TESTELEMENT: (for details see Annex 2)



Daidalos Peutz bouwfysisch ingenieursbureau
Vital Decosterstraat 67A – bus 1
B-3000 Leuven
Belgium
VAT: BE 0454.276.239
www.daidalospeutz.be



N° 451-TEST
NBN EN ISO 17025:2017
EA MLA signatory

NOISE LAB
REPORT Number A-2021LAB-061-13-15-44342_E

2. A_{obj} Zoover 120 at 50cm height

EQUIVALENT SOUND ABSORPTION AREA PER OBJECT

EN ISO 354:2003 Acoustics - Measurement of sound absorption in a reverberation room
EN ISO 11654:1997 Acoustics - Sound absorbers for use in buildings - Rating of sound absorption

Identification number of test element: **14**

Test date: 26/05/2021

Reverberation room: V = 298,3 m³ S_{tot} = 279,9 m²
Room conditions during measurements: Empty room With testelement
Temperature: T = 19,6 °C
Atmospheric pressure: p = 100,9 kPa
Relative humidity: h_r = 55 56,7 %

Type of test element: **Discrete object**

Construction characteristics: Number of tested objects 3
Number of location setups in the reverberation room 1

Test setup:

3 panels on a wooden frame
Height of the panels = 50 cm
Distance between each panel = 2 m

f(Hz)	T ₁ (s)	T ₂ (s)	A _{obj} [m ²]	σ ₉₅ (A _{obj})
50				
63				
80				
100	10,65	8,57	0,4	0,06
125	9,01	7,48	0,4	0,07
160	9,31	6,70	0,7	0,07
200	9,62	6,61	0,8	0,06
250	9,73	6,34	0,9	0,06
315	9,49	6,43	0,8	0,05
400	9,09	6,12	0,9	0,05
500	9,00	5,78	1,0	0,05
630	9,47	6,11	0,9	0,04
800	9,31	5,93	1,0	0,04
1000	9,28	5,86	1,0	0,03
1250	8,48	5,42	1,1	0,03
1600	7,50	4,90	1,1	0,03
2000	6,66	4,43	1,2	0,03
2500	5,61	3,84	1,3	0,04
3150	4,62	3,27	1,4	0,04
4000	3,58	2,68	1,5	0,05
5000	2,87	2,26	1,6	0,07

f(Hz)	A _{obj} [m ²]
125	0,5
250	0,8
500	0,9
1000	1,0
2000	1,2
4000	1,5

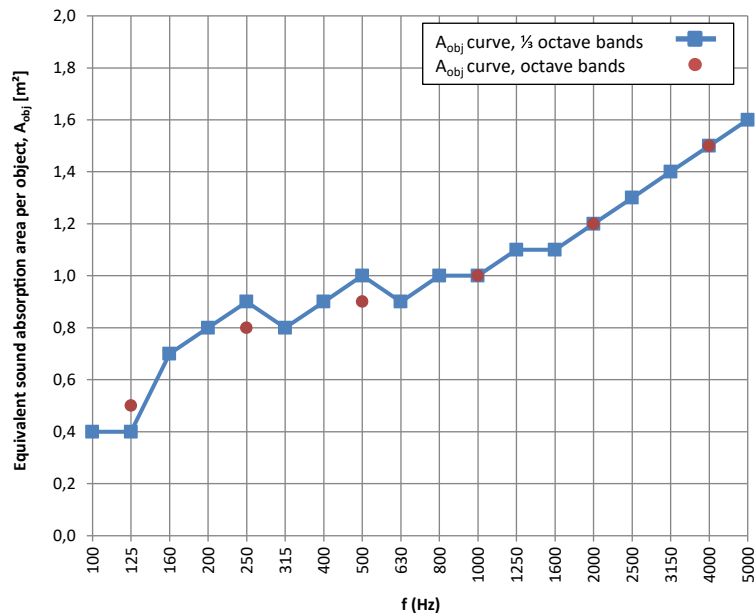

Note: an individual object is not evaluated according to ISO 11654 (α_w and class)

Requested by: Deltalight, Muizelstraat 2, B-8560 Wevelgem (Moorsele)
TESTELEMANT: (for details see Annex 2)



Daidalos Peutz bouwfysisch ingenieursbureau
Vital Decosterstraat 67A – bus 1
B-3000 Leuven
Belgium
VAT: BE 0454.276.239
www.daidalospeutz.be



N° 451-TEST
NBN EN ISO 17025:2017
EA MLA signatory

NOISE LAB
REPORT Number A-2021LAB-061-13-15-44342_E

3. A_{obj} Zoover 120 at 100cm height

EQUIVALENT SOUND ABSORPTION AREA PER OBJECT

EN ISO 354:2003 Acoustics - Measurement of sound absorption in a reverberation room
EN ISO 11654:1997 Acoustics - Sound absorbers for use in buildings - Rating of sound absorption

Identification number of test element: 15 **Test date:** 26/05/2021

Reverberation room: V = 298,3 m³ S_{tot} = 279,9 m²

Room conditions during measurements: Empty room With testelement

Temperature: T = 19,6 °C

Atmospheric pressure: p = 100,9 kPa

Relative humidity : h_r = 55 %

Type of test element: Discrete object

Construction characteristics:

Number of tested objects 3

Number of location setups in the reverberation room 1

Test setup:

3 panels on a wooden frame
Height of the panels = 100 cm
Distance between each panel = 2 m

f(Hz)	T ₁ (s)	T ₂ (s)	A _{obj} [m ²]	δ95 (A _{obj})
50				
63				
80				
100	10,65	9,39	0,2	0,06
125	9,01	8,03	0,2	0,07
160	9,31	7,68	0,4	0,06
200	9,62	7,33	0,5	0,05
250	9,73	6,65	0,8	0,05
315	9,49	6,34	0,8	0,05
400	9,09	5,94	0,9	0,05
500	9,00	5,86	1,0	0,05
630	9,47	6,05	1,0	0,04
800	9,31	5,94	1,0	0,04
1000	9,28	5,75	1,1	0,03
1250	8,48	5,33	1,1	0,03
1600	7,50	4,84	1,2	0,03
2000	6,66	4,33	1,3	0,04
2500	5,61	3,81	1,4	0,04
3150	4,62	3,26	1,5	0,05
4000	3,58	2,67	1,6	0,06
5000	2,87	2,23	1,6	0,07

f(Hz)	A _{obj} [m ²]
125	0,3
250	0,7
500	1,0
1000	1,1
2000	1,3
4000	1,6

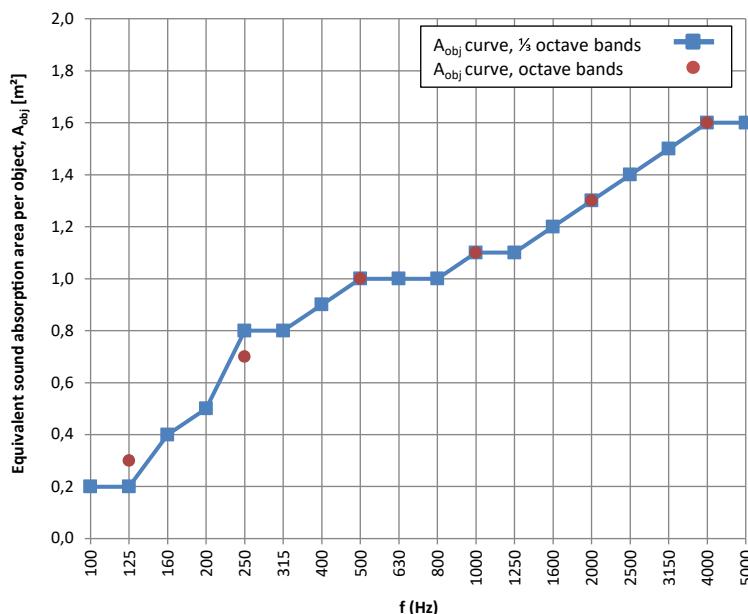

Note: an individual object is not evaluated according to ISO 11654 (α_w and class)

Requested by: Deltalight, Muizelstraat 2, B-8560 Wevelgem (Moorsele)
TESTELEMANT: (for details see Annex 2)



Daidalos Peutz bouwfysisch ingenieursbureau
Vital Decosterstraat 67A – bus 1
B-3000 Leuven
Belgium
VAT: BE 0454.276.239
www.daidalospeutz.be



N° 451-TEST
NBN EN ISO 17025:2017
EA MLA signatory

NOISE LAB
REPORT Number A-2021LAB-061-13-15-44342_E

ANNEX 1 : PRECISION

The relative standard deviation of the reverberation time T20

$\varepsilon_{20} =$ The relative standard deviation of the reverberation time T20, evaluated over a 20dB decay range, can be estimated by the following formula (see 8.2.2. van ISO 354:2003)

$$\varepsilon_{20}(T) = T \sqrt{\frac{2,42 + 3,59/N}{f T}}$$

T_1 (s) = reverberation time of the empty room
 T_2 (s) = reverberation time of the reverberation room after with the test specimen
 f (Hz) = centre frequency of the one-third-octave band
 N = number of decay curves evaluated

The relative standard deviation of the sound absorption coefficient

$\varepsilon(A_{obj}) =$ The relative standard deviation of The relative standard deviation of the sound absorption coefficient

$$\varepsilon(A_{obj}) = \frac{55,3 V}{c S} \sqrt{\left(\frac{\varepsilon_{20}(T_2)}{T_2^2}\right)^2 + \left(\frac{\varepsilon_{20}(T_1)}{T_1^2}\right)^2}$$

$\delta_{95}(A_{obj}) =$ 95% confidence interval 95% confidence interval

$$\delta_{95}(A_{obj}) = \frac{1,96 \varepsilon(\alpha)}{\sqrt{N}}$$

T_1 (s) = reverberation time of the empty room
 T_2 (s) = reverberation time of the reverberation room after with the test specimen
 V = Volume of the reverberation room
 c = the propagation speed of sound in air

 N = number of decay curves evaluated
 S = the area, in square metres, covered by the test specimen

Daidalos Peutz bouwfysisch ingenieursbureau
 Vital Decosterstraat 67A – bus 1
 B-3000 Leuven
 Belgium
 VAT: BE 0454.276.239
www.daidalospeutz.be



N° 451-TEST
 NBN EN ISO 17025:2017
 EA MLA signatory

NOISE LAB
REPORT Number A-2021LAB-061-13-15-44342_E

ANNEX 2: Description test items by manufacturer

The test sample description given by manufacturer is checked visually as good as possible by the laboratory.
 The correspondence between the test element and the commercialized product is the sole responsibility of the manufacturer

Zoover 120

Material: PET felt
 Diameter of the panel: 1200 mm
 Thickness of the panel: 7 mm
 Height of the panel: 150 mm
 Weight tolerance: 2082gr - 10% + 13% (Min. 1873gr. Max. 2354gr)

Height of the wooden frame (suspension height of the panel): 5 cm, 50 cm and 100 cm

Photo: Zoover 120 panel with light



Photo: Back side of Zoover 120



Photo of the light

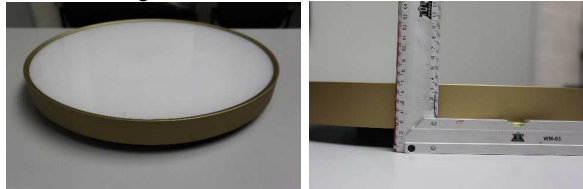



Daidalos Peutz bouwfysisch ingenieursbureau
Vital Decosterstraat 67A – bus 1
B-3000 Leuven
Belgium
VAT: BE 0454.276.239
www.daidalospeutz.be



N° 451-TEST
NBN EN ISO 17025:2017
EA MLA signatory

NOISE LAB
REPORT Number A-2021LAB-061-13-15-44342_E

ANNEX 3: Technical datasheet

The test sample description given by manufacturer is checked visually as good as possible by the laboratory.
The correspondence between the test element and the commercialized product is the sole responsibility of the manufacturer

Further information can be obtained from the manufacturer

Daidalos Peutz bouwfysisch ingenieursbureau
Vital Decosterstraat 67A – bus 1
B-3000 Leuven
Belgium
VAT: BE 0454.276.239
www.daidalospeutz.be



N° 451-TEST
NBN EN ISO 17025:2017
EA MLA signatory

NOISE LAB
REPORT Number A-2021LAB-061-13-15-44342_E

ANNEX 4A: technical drawings of the test element or the test arrangement

Description of the assembly or drawing or photo

Technical drawing:

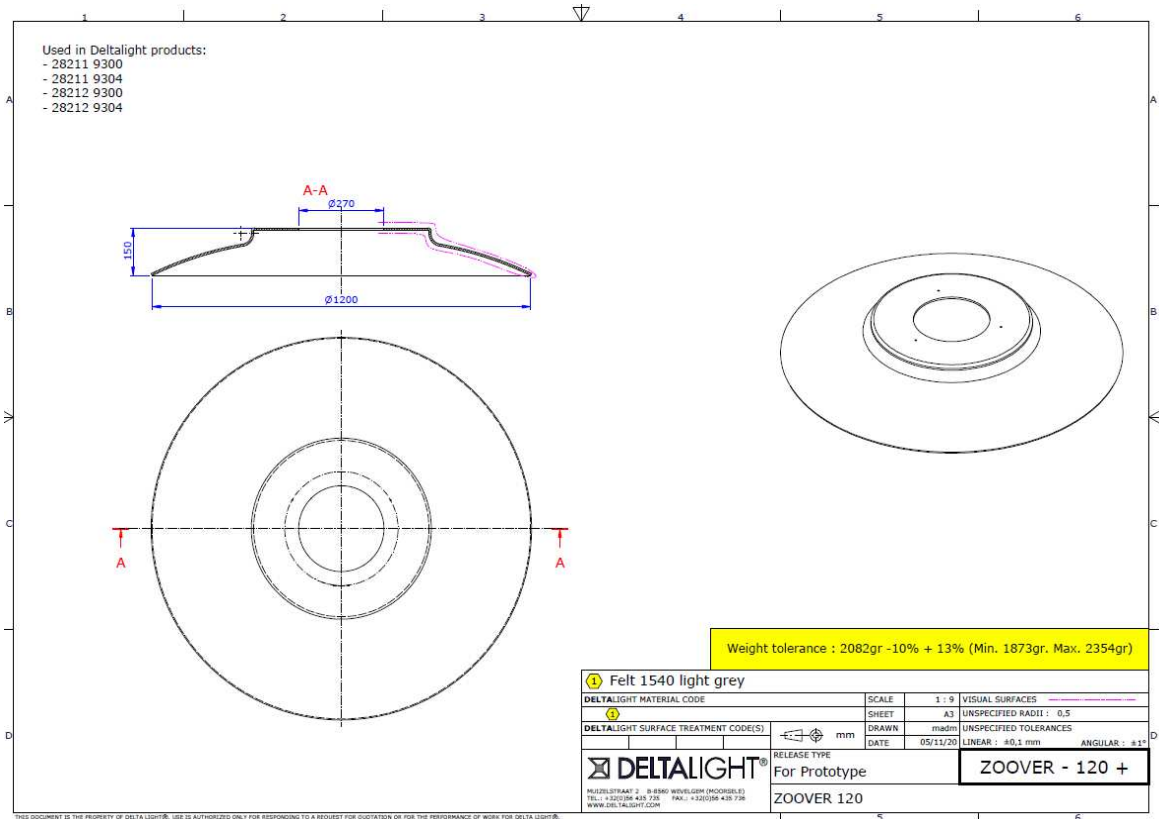



Daidalos Peutz bouwfysisch ingenieursbureau
Vital Decosterstraat 67A – bus 1
B-3000 Leuven
Belgium
VAT: BE 0454.276.239
www.daidalospeutz.be



N° 451-TEST
NBN EN ISO 17025:2017
EA MLA signatory

NOISE LAB
REPORT Number A-2021LAB-061-13-15-44342_E

ANNEX 4B: photographs of the test element or the test arrangement

Description of the assembly or drawing or photo

Three configurations were tested:
Zoover 120 with suspension height 5 cm, 50 cm and 100 cm
Per configuration, 3 panels were placed in the reverberation room.

The test specimen comprise a sufficient number of individual objects (3 panels) to provide a measurable change in the equivalent sound absorption area of the room AT greater than $1,31 \text{ m}^2 \text{ (V/200m}^2\text{)}^{2/3}$
AT (100 Hz - 5000 Hz) with Zoover 120, height 5 cm = $2,77 \text{ m}^2$
AT (100 Hz - 5000 Hz) with Zoover 120, height 50 cm = 3 m^2
AT (100 Hz - 5000 Hz) with Zoover 120, height 100 cm = $2,92 \text{ m}^2$
The objects were arranged randomly, spaced at least 2m apart and 1m away to any other boundary.

Photos top to bottom from measurement 13:
Zoover 120 - height 5 cm

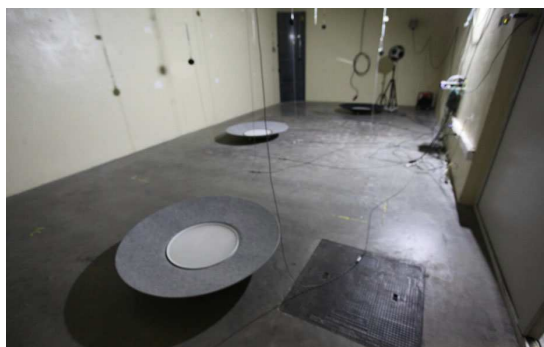

Photos top to bottom from measurement 14:
Zoover 120 - height 50 cm

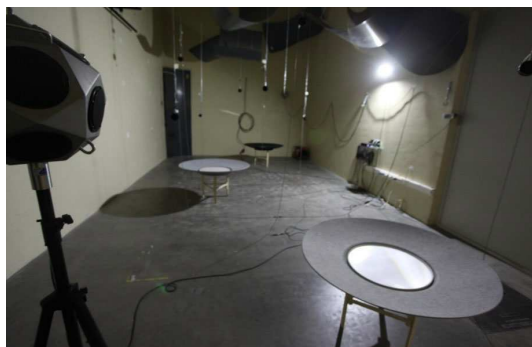

Daidalos Peutz bouwfysisch ingenieursbureau
Vital Decosterstraat 67A – bus 1
B-3000 Leuven
Belgium
VAT: BE 0454.276.239
www.daidalospeutz.be



N° 451-TEST
NBN EN ISO 17025:2017
EA MLA signatory

NOISE LAB
REPORT Number A-2021LAB-061-13-15-44342_E

ANNEX 4B: photographs of the test element or the test arrangement

Description of the assembly or drawing or photo

Three configurations were tested:
Zoover 120 with suspension height 5 cm, 50 cm and 100 cm
Per configuration, 3 panels were placed in the reverberation room.

The test specimen comprise a sufficient number of individual objects (3 panels) to provide a measurable change in the equivalent sound absorption area of the room AT greater than $1,31 \text{ m}^2$ ($V/200\text{m}^2 \cdot 2/3$)

AT (100 Hz - 5000 Hz) with Zoover 120, height 5 cm = $2,77 \text{ m}^2$

AT (100 Hz - 5000 Hz) with Zoover 120, height 50 cm = 3 m^2

AT (100 Hz - 5000 Hz) with Zoover 120, height 100 cm = $2,92 \text{ m}^2$

The objects were arranged randomly, spaced at least 2m apart and 1m away to any other boundary.

Photos top to bottom from measurement 15:

Zoover 120 - height 100 cm

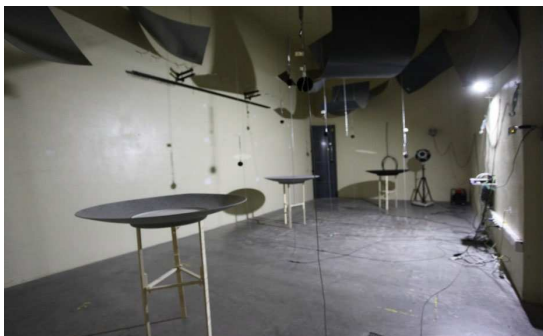

Daidalos Peutz bouwfysisch ingenieursbureau
Vital Decosterstraat 67A – bus 1
B-3000 Leuven
Belgium
VAT: BE 0454.276.239
www.daidalospeutz.be



N° 451-TEST
NBN EN ISO 17025:2017
EA MLA signatory

NOISE LAB
REPORT Number A-2021LAB-061-13-15-44342_E

ANNEX 5: Sketch of the test room

The test room was built and finished according ISO 354.

Reverberation Room (according EN ISO 354)

