



## SPECSHEET ZOOVER 140



<b>1. Properties of the basic material</b>	P2
1.1. Weighted sound absorption coefficient	
1.2. Fire classification	
<b>2. Equivalent sound absorption area per object (<math>A_{obj}</math>) of ZOOVER 140</b>	
2.1. At <b>0,5m</b> from ceiling	P3
2.2. At <b>1m</b> from ceiling	P4
<b>3. Official report</b>	P5



## 1. Properties of the basic material

1.1. Weighted sound absorption coefficient  
according to: **to be confirmed**

1.2. Fire classification

According to: **to be confirmed**

## 2. Equivalent sound absorption area per object ( $A_{obj}$ ) of ZOOVER 140

Frequency-dependent value of the sound absorption coefficient which is based on measurements on one-third-octave bands in accordance with ISO 354 and which is calculated in octave bands in accordance with the standard ISO 11654:1997.

The equivalent sound absorption area for each octave band  $i$ , is calculated from the arithmetic mean value of the three one-third octave sound absorption coefficients within the octave. In line with the standard ISO 354, the mean value is calculated to the first decimal.



**2.1. At 0,5m from ceiling**

EN ISO 354:2003

Acoustics - Measurement of sound absorption in a reverberation room

EN ISO 11654:1997

Acoustics - Sound absorbers for use in buildings - Rating of sound absorption

**Identification number of test element:** 19

**Test date:** 26/05/2021

**Reverberation room:**

V = 298,3 m<sup>3</sup>

S<sub>tot</sub> = 279,9 m<sup>2</sup>

**Room conditions during measurements:**

Temperature:

T = 19,6 °C

With testelement

Atmospheric pressure:

p = 100,9 kPa

19,2 °C

Relative humidity :

h<sub>r</sub> = 55 %

101,0 kPa

57,0 %

**Type of test element:**

**Discrete object**

**Construction characteristics:**

Number of tested objects

3

Number of location setups in the reverberation room

1

Test setup:

3 panels on a wooden frame  
Height of the panels = 50 cm  
Distance between each panel = 2 m

f(Hz)	T <sub>1</sub> (s)	T <sub>2</sub> (s)	A <sub>obj</sub> [m <sup>2</sup> ]	δ <sub>95</sub> (A <sub>obj</sub> )
50				
<b>63</b>				
80				
100	10,65	8,68	0,3	0,06
<b>125</b>	<b>9,01</b>	<b>6,46</b>	<b>0,7</b>	0,08
160	9,31	6,33	0,8	0,07
200	9,62	6,45	0,8	0,06
<b>250</b>	<b>9,73</b>	<b>5,94</b>	<b>1,1</b>	0,06
315	9,49	5,56	1,2	0,06
400	9,09	5,12	1,4	0,06
<b>500</b>	<b>9,00</b>	<b>5,08</b>	<b>1,4</b>	0,05
630	9,47	5,17	1,4	0,05
800	9,31	5,02	1,5	0,04
<b>1000</b>	<b>9,28</b>	<b>4,97</b>	<b>1,5</b>	0,04
1250	8,48	4,61	1,6	0,04
1600	7,50	4,22	1,7	0,04
<b>2000</b>	<b>6,66</b>	<b>3,84</b>	<b>1,8</b>	0,04
2500	5,61	3,36	1,9	0,05
3150	4,62	2,92	2,0	0,05
<b>4000</b>	<b>3,58</b>	<b>2,44</b>	<b>2,2</b>	0,06
5000	2,87	2,05	2,3	0,07

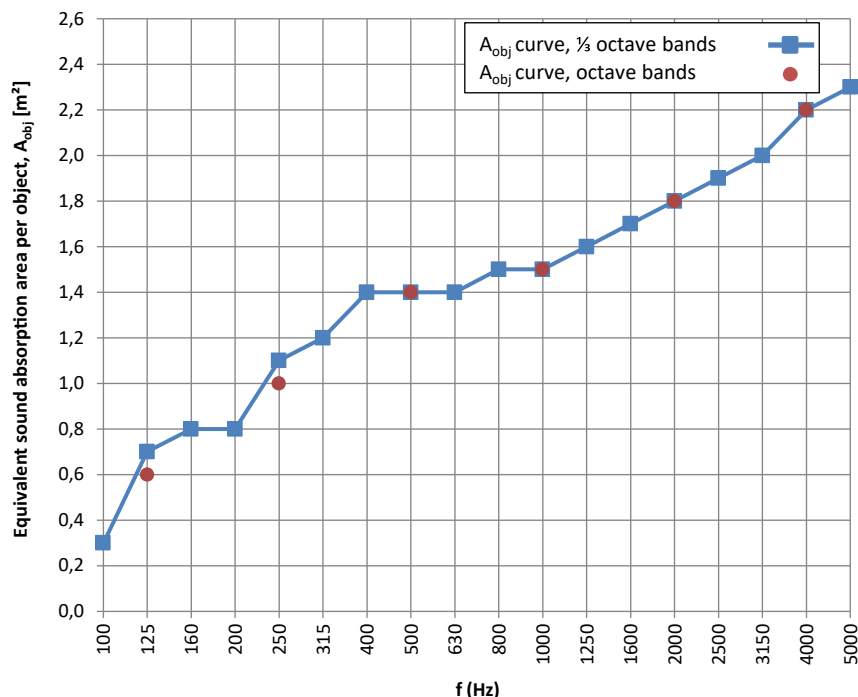

**Note:** an individual object is not evaluated according to ISO 11654 (α<sub>w</sub> and class)

f(Hz)	A <sub>obj</sub> [m <sup>2</sup> ]
125	0,6
250	1,0
500	1,4
1000	1,5
2000	1,8
4000	2,2

**Requested by:** Deltalight, Muizelstraat 2, B-8560 Wevelgem (Moorsele)

**TESTELEMET:** (for details see Annex 2)



**2.2. At 1m from ceiling**

EN ISO 354:2003

Acoustics - Measurement of sound absorption in a reverberation room

EN ISO 11654:1997

Acoustics - Sound absorbers for use in buildings - Rating of sound absorption

Identification number of test element: **20**

Test date: 26/05/2021

Reverberation room:

V = 298,3 m<sup>3</sup>

S<sub>tot</sub> = 279,9 m<sup>2</sup>

Room conditions during measurements:

Temperature:

T = 19,6

With testelement 19,2 °C

Atmospheric pressure:

p = 100,9

101,1 kPa

Relative humidity :

h<sub>r</sub> = 55

57,3 %

Type of test element:

**Discrete object**

Construction characteristics:

Number of tested objects

3

Number of location setups in the reverberation room

1

Test setup:

3 panels on a wooden frame  
Height of the panels = 100 cm  
Distance between each panel = 2 m

f(Hz)	T <sub>1</sub> (s)	T <sub>2</sub> (s)	A <sub>obj</sub> [m <sup>2</sup> ]	δ95 (Aobj)
50				
<b>63</b>				
80				
100	10,65	8,42	0,4	0,06
<b>125</b>	<b>9,01</b>	<b>6,85</b>	<b>0,6</b>	<b>0,08</b>
160	9,31	6,94	0,6	0,07
200	9,62	6,42	0,8	0,06
<b>250</b>	<b>9,73</b>	<b>5,66</b>	<b>1,2</b>	<b>0,07</b>
315	9,49	5,77	1,1	0,06
400	9,09	5,20	1,3	0,06
<b>500</b>	<b>9,00</b>	<b>5,11</b>	<b>1,4</b>	<b>0,05</b>
630	9,47	5,13	1,4	0,05
800	9,31	5,00	1,5	0,04
<b>1000</b>	<b>9,28</b>	<b>4,93</b>	<b>1,5</b>	<b>0,04</b>
1250	8,48	4,55	1,6	0,04
1600	7,50	4,19	1,7	0,04
<b>2000</b>	<b>6,66</b>	<b>3,79</b>	<b>1,8</b>	<b>0,04</b>
2500	5,61	3,36	1,9	0,05
3150	4,62	2,91	2,1	0,05
<b>4000</b>	<b>3,58</b>	<b>2,42</b>	<b>2,2</b>	<b>0,06</b>
5000	2,87	2,02	2,4	0,07

f(Hz)	A <sub>obj</sub> [m <sup>2</sup> ]
125	0,5
250	1,0
500	1,4
1000	1,5
2000	1,8
4000	2,2

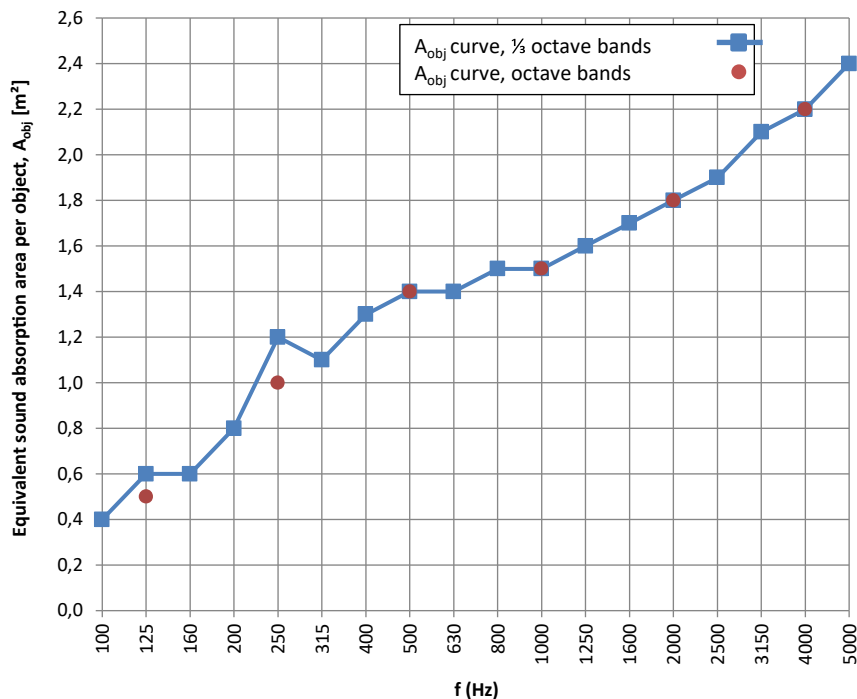

Note: an individual object is not evaluated according to ISO 11654 (α<sub>w</sub> and class)

Requested by: Deltalight, Muizelstraat 2, B-8560 Wevelgem (Moorsele)

TESTELEMEN: (for details see Annex 2)

**3. Official report**



**Daidalos Peutz** bouwfysisch ingenieursbureau  
Vital Decosterstraat 67A – bus 1  
B-3000 Leuven  
Belgium  
VAT: BE 0454.276.239  
[www.daidalospeutz.be](http://www.daidalospeutz.be)



N° 451-TEST  
NBN EN ISO 17025:2017  
EA MLA signatory

**NOISE LAB**  
**REPORT Number A-2021LAB-061-18-20-44342\_E**

**Customer :** Deltalight  
Muizelstraat 2  
B-8560 Wevelgem (Moorsele)  
Belgium  
Techsupport@deltalight.com

**Contacts :** **Client :** Deltalight  
**Noise lab :** Gert-Jan Loobuyck

**Tests :** Measurement of sound absorption in the reverberation room

**Product name :** Zoover 140

**Normative references:**  
**NBN EN ISO 354:2003** Acoustics - Measurement of sound absorption in a reverberation room  
  
NBN EN ISO 11654:1997 Acoustics - Sound absorbers for use in buildings - Rating of sound absorption  
NBN ISO 9613-1:1996 Acoustics - Attenuation of sound during propagation outdoors -  
part 1 : Calculation of the absorption of sound by the atmosphere  
ISO 12999-2:2020 Acoustics - Determination and application of measurement uncertainties in building acoustics  
Part 2: Sound absorption

To perform the above measurements, the laboratory of Daidalos Peutz is accredited by BELAC, "The Belgian Accreditation Body", under the certificate nr N°451-TEST. The activities covered by this accreditation certificate are covered by the EA MLA.  
BELAC is a signatory of all existing multilateral agreements and recognition agreements of International Laboratory Accreditation Cooperation (ILAC).  
In this way, reports issued by BELAC accredited bodies are internationally accredited.

<b>Date and reference of the request:</b>	9/04/2021	2021LAB-061
<b>Date of receipt of the specimen(s):</b>	26/05/2021	
<b>Date of construction:</b>	26/05/2021	till 26/05/2021
<b>Date of tests:</b>	26/05/2021	till 26/05/2021
<b>Date of preparation of the report:</b>	7/06/2021	

This test report together with its annexes contains : 14 pages and must be multiplied only in its entirety

Technical Manager,

Paul Mees

Laboratory Worker,

Gert-Jan Loobuyck



**Daidalos Peutz** bouwfysisch ingenieursbureau  
Vital Decosterstraat 67A – bus 1  
B-3000 Leuven  
Belgium  
VAT: BE 0454.276.239  
[www.daidalospeutz.be](http://www.daidalospeutz.be)



**N° 451-TEST**  
NBN EN ISO 17025:2017  
EA MLA signatory

**NOISE LAB**  
**REPORT Number A-2021LAB-061-18-20-44342\_E**

**MEASURING EQUIPMENT**

**Signal**

Brüel & Kjaer - 4292 : Omni Power Sound Source

**Microphone system:**

Brüel & Kjaer - 4189-L-001 : 1/2" free field microphone prepolarized, inclusive 2669L TEDS  
Brüel & Kjaer - 4189 : 1/2" free field microphone, 6Hz to 20kHz, prepolarized  
Brüel & Kjaer - 2669 : 1/2" microphone preamplifier  
Brüel & Kjaer - 4231 : Sound calibrator 94&114dB SPL-1000Hz, Fulfils IEC 60942(2003)Class1

Number of source positions:	2	(Different sound source positions at least 3m apart.
Number of microphone positions for each source position:	8	The measurements shall be made with different microphone positions
Number of measured decays curves:	3	which are at least 1,5m apart, 2m from any sound source and 1m from any room surface and the test specimen.)
Total number of measurements with different positions for microphone & source:	16	

**Signal processing**

Brüel & Kjaer - 2716C : Power amplifier  
Brüel & Kjaer - 3050-A-6/0: Signal generator, 6-ch. Inputmodule LAN-XI  
Brüel & Kjaer - 3160-A-042: Signal generator, 4/2-ch. Input/output module LAN-XI  
Brüel & Kjaer : PULSE Labshop Version 13.5  
A PC with all necessary software

**Reverberation room**

Dimensions of the room:	Total volume :	298,3 m <sup>3</sup>
	Length:	9,99 m
	Width	4,97 m
	Height	5,98 m
	Volume door opening :	1,32 m <sup>3</sup>
	Total area:	279,9 m <sup>2</sup>
	$I_{max} = 12,65 \text{ m} < 1,9 \text{ V}^{1/3}$	

In order to improve the diffusivity, the use of diffusers is necessary  
The test specimen shall have a maximum area of 15,62 m<sup>2</sup>, which depends on the room volume



**Daidalos Peutz** bouwfysisch ingenieursbureau  
 Vital Decosterstraat 67A – bus 1  
 B-3000 Leuven  
 Belgium  
 VAT: BE 0454.276.239  
[www.daidalospeutz.be](http://www.daidalospeutz.be)



**N° 451-TEST**  
 NBN EN ISO 17025:2017  
 EA MLA signatory

**NOISE LAB**  
**REPORT Number A-2021LAB-061-18-20-44342\_E**

**TEST METHOD**

The tests were conducted in accordance with the provisions of the test method EN ISO354:2003. A detailed description of the test set up has been given in the figures of annex 1 of this report.

The measurement method can be simply described as follows:

Essence of the test is in measuring of the reverberation time in the empty reflecting room and in the same room with the test sample inside it. The sound-absorption properties of a material depend on how the material is mounted during the test. Annex B of ISO 354:2003 specifies several different standard mountings that shall be used during a test for sound absorption. Normally a test specimen is tested using only one of the specified mountings.

From these reverberation times, the equivalent sound absorption area of the test specimen, is calculated by using Sabine's equation. Measurement is carried out in ranges of 1/3 octave and interval from 100Hz to 5000Hz.

The equivalent sound absorption area of the empty reverberation room, A<sub>1</sub>, in square metres, shall be calculated using the formula (1) :

$$A_1 = 55,3 V / (c_1 T_1) - 4V m_1 \quad [m^2] \quad (1)$$

The equivalent sound absorption area of the reverberation room containing a test specimen, A<sub>2</sub>, in square metres, shall be calculated using the formula (2) :

$$A_2 = 55,3 V / (c_2 T_2) - 4V m_2 \quad [m^2] \quad (2)$$

The equivalent sound absorption area of the test specimen, A<sub>T</sub>, in square metres, shall be calculated using the formula (3) :

$$A_T = A_2 - A_1 = 55,3 V (1/c_2 T_2 - 1/c_1 T_1) - 4V(m_2 - m_1) \quad [m^2] \quad (3)$$

The sound absorption coefficient of a plane absorber or a specified array of test objects shall be calculated using the formula (4):

$$\alpha_s = A_T / S \quad (4)$$

**NOTE** For discrete objects A<sub>obj</sub> is used instead of α<sub>s</sub>  
 For a specific array of objects the result is given as α<sub>s</sub>

The equivalent sound absorption area of discrete absorbers or individual objects shall be calculated using the formula (5):

$$A_{obj} = A_T / n \quad \text{where } n \text{ is the number of tested objects} \quad (5)$$

- whereas:
- A<sub>1</sub> = The equivalent sound absorption area of the empty reverberation room in square metres
  - A<sub>2</sub> = The equivalent sound absorption area of the reverberation room containing a test specimen in square metres
  - V = volume, in cubic metres, of the empty reverberation room [m<sup>3</sup>]
  - c<sub>1</sub>, c<sub>2</sub> = the propagation speed of sound in air, in [m/s], calculated using the formula  
 (in function of the temperature in the room during the test)  
 $c = 331 + 0,6 t$  with t = the air temperature in degrees Celsius for temperatures in the range of 15°C to 30°C
  - T<sub>1</sub> = the reverberation time, in seconds, of the empty reverberation room
  - T<sub>2</sub> = the reverberation time, in seconds, of the reverberation room after the test specimen has been introduced
  - m<sub>1</sub>, m<sub>2</sub> = the power attenuation coefficient, in reciprocal metres, calculated according to ISO 9613-1:1993
  - A<sub>T</sub> = The equivalent sound absorption area of the test specimen in square metres
  - S = the area, in square metres, covered by the test specimen
  - α<sub>s</sub> = the sound absorption coefficient
  - A<sub>obj</sub> = the equivalent sound absorption area per object
  - n = the number of tested discrete or individual objects

**SPECIAL MEASUREMENT CONDITIONS**

n/a



**Daidalos Peutz** bouwfysisch ingenieursbureau  
Vital Decosterstraat 67A – bus 1  
B-3000 Leuven  
Belgium  
VAT: BE 0454.276.239  
[www.daidalospeutz.be](http://www.daidalospeutz.be)



N° 451-TEST  
NBN EN ISO 17025:2017  
EA MLA signatory

**NOISE LAB**  
**REPORT Number A-2021LAB-061-18-20-44342\_E**

**RATING OF SOUND ABSORPTION**

**$A_{obj}$  EQUIVALENT SOUND ABSORPTION AREA PER OBJECT**

Frequency-dependent value of the sound absorption coefficient which is based on measurements on one-third-octave bands in accordance with ISO 354 and which is calculated in octave bands in accordance with the standard ISO 11654:1997.  
The equivalent sound absorption area for each octave band  $i$ , is calculated from the arithmetic mean value of the three one-third octave sound absorption coefficients within the octave. In line with the standard ISO 354, the mean value is calculated to the first decimal.

**$\alpha_w$  WEIGHTED SOUND ABSORPTION COEFFICIENT**

The weighted sound absorption coefficient is determined as a single number value from the practical sound absorption coefficients from 250 Hz to 4000 Hz. The practical sound absorption coefficient is calculated according to ISO 11654:1997.  
Single-number frequency-independent value which equals the value of the reference curve at 500 Hz after shifting is as specified in the standard ISO 11654:1997.

But an individual object is NOT evaluated with the standard ISO 11654, both in terms of the single-number value and the absorption class.

Test results related to tested object only. The test results should not be considered as material constants, the absorption depends not only on the material itself. The method of construction, the size of the material surface and its place in the room, affect the sound absorption characteristics of the test element.

**ACCURACY**

The accuracy of the absorption coefficients as calculated can be expressed in terms of repeatability of measured reverberation times (tests within one laboratory) and reproducibility (between various laboratories)

The relative standard deviation of the reverberation time  $T_{20}$ , evaluated over a 20dB decay range, can be estimated by the following formula (see 8.2.2. van ISO 354:2003)

These relative standard deviations of the reverberation time  $T_{20}$  were calculated and illustrated in annex 1.

The reproducibility of absorption coefficient measurement is still under investigation

The specific value of uncertainty is available on request





**Daidalos Peutz** bouwfysisch ingenieursbureau  
Vital Decosterstraat 67A – bus 1  
B-3000 Leuven  
Belgium  
VAT: BE 0454.276.239  
[www.daidalospeutz.be](http://www.daidalospeutz.be)



**N° 451-TEST**  
NBN EN ISO 17025:2017  
EA MLA signatory

**NOISE LAB**  
**REPORT Number A-2021LAB-061-18-20-44342\_E**

**1. A<sub>obj</sub> Zoover 140 at 5cm height**

**EQUIVALENT SOUND ABSORPTION AREA PER OBJECT**

EN ISO 354:2003 Acoustics - Measurement of sound absorption in a reverberation room  
EN ISO 11654:1997 Acoustics - Sound absorbers for use in buildings - Rating of sound absorption

Identification number of test element: **18**

Test date: 26/05/2021

Reverberation room: V = 298,3 m<sup>3</sup> S<sub>tot</sub> = 279,9 m<sup>2</sup>  
Room conditions during measurements: Empty room With testelement  
Temperature: T = 19,6 °C  
Atmospheric pressure: p = 100,9 kPa  
Relative humidity: h<sub>r</sub> = 55 %

Type of test element: **Discrete object**

Construction characteristics:  
Number of tested objects: 3  
Number of location setups in the reverberation room: 1

Test setup:

3 panels on wooden blocks  
Height of the panels = 5 cm  
Distance between each panel = 2 m

f(Hz)	T <sub>1</sub> (s)	T <sub>2</sub> (s)	A <sub>obj</sub> [m <sup>2</sup> ]	δ <sub>95</sub> (A <sub>obj</sub> )
50				
63				
80				
100	10,65	9,57	0,2	0,06
125	9,01	7,71	0,3	0,07
160	9,31	7,16	0,5	0,06
200	9,62	6,69	0,7	0,06
250	9,73	5,41	1,3	0,07
315	9,49	4,85	1,6	0,07
400	9,09	4,75	1,6	0,07
500	9,00	4,62	1,7	0,06
630	9,47	4,88	1,6	0,05
800	9,31	4,90	1,6	0,04
1000	9,28	4,93	1,5	0,04
1250	8,48	4,70	1,5	0,04
1600	7,50	4,43	1,5	0,04
2000	6,66	4,03	1,6	0,04
2500	5,61	3,58	1,6	0,04
3150	4,62	3,12	1,7	0,05
4000	3,58	2,56	1,8	0,06
5000	2,87	2,13	2,0	0,07

f(Hz)	A <sub>obj</sub> [m <sup>2</sup> ]
125	0,3
250	1,2
500	1,6
1000	1,5
2000	1,6
4000	1,8

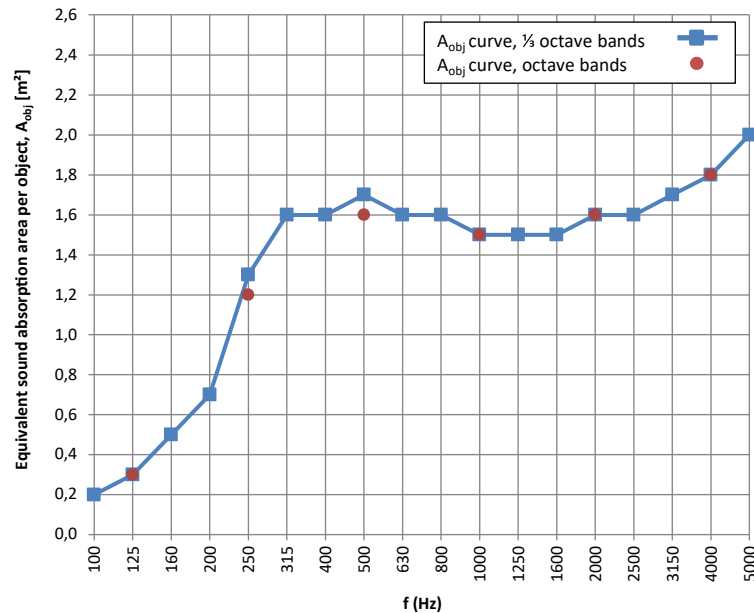

Note: an individual object is not evaluated according to ISO 11654 (α<sub>w</sub> and class)

Requested by: Deltalight, Muizelstraat 2, B-8560 Wevelgem (Moorsele)  
TESTELEMANT: (for details see Annex 2)



**Daidalos Peutz** bouwfysisch ingenieursbureau  
Vital Decosterstraat 67A – bus 1  
B-3000 Leuven  
Belgium  
VAT: BE 0454.276.239  
[www.daidalospeutz.be](http://www.daidalospeutz.be)



**N° 451-TEST**  
NBN EN ISO 17025:2017  
EA MLA signatory

**NOISE LAB**  
**REPORT Number A-2021LAB-061-18-20-44342\_E**

**2. A<sub>obj</sub> Zoover 140 at 50cm height**

**EQUIVALENT SOUND ABSORPTION AREA PER OBJECT**

EN ISO 354:2003 Acoustics - Measurement of sound absorption in a reverberation room  
EN ISO 11654:1997 Acoustics - Sound absorbers for use in buildings - Rating of sound absorption

**Identification number of test element:** 19

**Test date:** 26/05/2021

**Reverberation room:** V = 298,3 m<sup>3</sup> S<sub>tot</sub> = 279,9 m<sup>2</sup>  
**Room conditions during measurements:** Empty room With testelement  
**Temperature:** T = 19,6 °C  
**Atmospheric pressure:** p = 100,9 kPa  
**Relative humidity :** h<sub>r</sub> = 55 %

**Type of test element:** Discrete object

**Construction characteristics:**  
Number of tested objects 3  
Number of location setups in the reverberation room 1

**Test setup:** 3 panels on a wooden frame  
Height of the panels = 50 cm  
Distance between each panel = 2 m

f(Hz)	T <sub>1</sub> (s)	T <sub>2</sub> (s)	A <sub>obj</sub> [m <sup>2</sup> ]	δ95 (A <sub>obj</sub> )
50				
63				
80				
100	10,65	8,68	0,3	0,06
125	9,01	6,46	0,7	0,08
160	9,31	6,33	0,8	0,07
200	9,62	6,45	0,8	0,06
250	9,73	5,94	1,1	0,06
315	9,49	5,56	1,2	0,06
400	9,09	5,12	1,4	0,06
500	9,00	5,08	1,4	0,05
630	9,47	5,17	1,4	0,05
800	9,31	5,02	1,5	0,04
1000	9,28	4,97	1,5	0,04
1250	8,48	4,61	1,6	0,04
1600	7,50	4,22	1,7	0,04
2000	6,66	3,84	1,8	0,04
2500	5,61	3,36	1,9	0,05
3150	4,62	2,92	2,0	0,05
4000	3,58	2,44	2,2	0,06
5000	2,87	2,05	2,3	0,07

f(Hz)	A <sub>obj</sub> [m <sup>2</sup> ]
125	0,6
250	1,0
500	1,4
1000	1,5
2000	1,8
4000	2,2

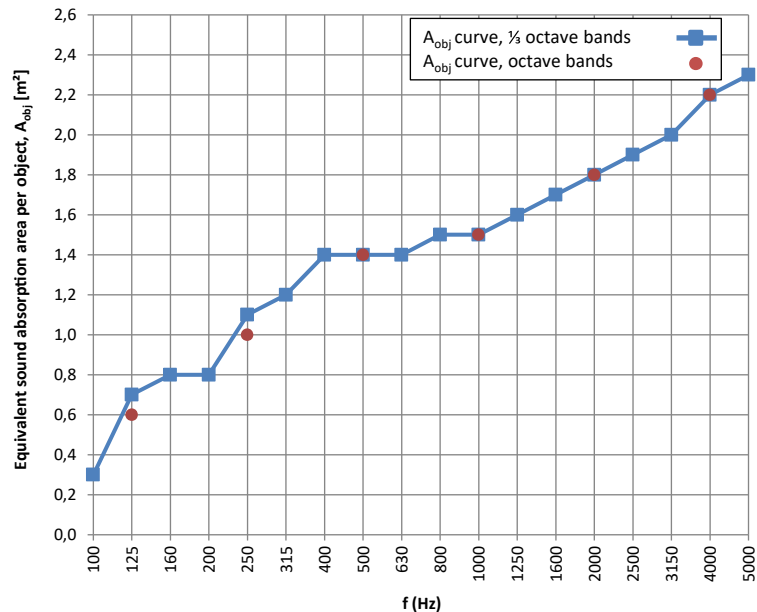

**Note:** an individual object is not evaluated according to ISO 11654 (α<sub>w</sub> and class)

**Requested by:** Deltalight, Muizelstraat 2, B-8560 Wevelgem (Moorsele)  
**TESTELEMANT:** (for details see Annex 2)



**Daidalos Peutz** bouwfysisch ingenieursbureau  
Vital Decosterstraat 67A – bus 1  
B-3000 Leuven  
Belgium  
VAT: BE 0454.276.239  
[www.daidalospeutz.be](http://www.daidalospeutz.be)



**N° 451-TEST**  
NBN EN ISO 17025:2017  
EA MLA signatory

**NOISE LAB**  
**REPORT Number A-2021LAB-061-18-20-44342\_E**

**3. A<sub>obj</sub> Zoover 140 at 100cm height**

**EQUIVALENT SOUND ABSORPTION AREA PER OBJECT**

EN ISO 354:2003 Acoustics - Measurement of sound absorption in a reverberation room  
EN ISO 11654:1997 Acoustics - Sound absorbers for use in buildings - Rating of sound absorption

**Identification number of test element:** 20 **Test date:** 26/05/2021

**Reverberation room:** V = 298,3 m<sup>3</sup> S<sub>tot</sub> = 279,9 m<sup>2</sup>

**Room conditions during measurements:** Empty room With testelement

**Temperature:** T = 19,6 °C

**Atmospheric pressure:** p = 100,9 kPa

**Relative humidity :** h<sub>r</sub> = 55 %

**Type of test element:** Discrete object

**Construction characteristics:** Number of tested objects 3  
Number of location setups in the reverberation room 1

**Test setup:** 3 panels on a wooden frame  
Height of the panels = 100 cm  
Distance between each panel = 2 m

f(Hz)	T <sub>1</sub> (s)	T <sub>2</sub> (s)	A <sub>obj</sub> [m <sup>2</sup> ]	σ <sub>95</sub> (A <sub>obj</sub> )
50				
63				
80				
100	10,65	8,42	0,4	0,06
125	9,01	6,85	0,6	0,08
160	9,31	6,94	0,6	0,07
200	9,62	6,42	0,8	0,06
250	9,73	5,66	1,2	0,07
315	9,49	5,77	1,1	0,06
400	9,09	5,20	1,3	0,06
500	9,00	5,11	1,4	0,05
630	9,47	5,13	1,4	0,05
800	9,31	5,00	1,5	0,04
1000	9,28	4,93	1,5	0,04
1250	8,48	4,55	1,6	0,04
1600	7,50	4,19	1,7	0,04
2000	6,66	3,79	1,8	0,04
2500	5,61	3,36	1,9	0,05
3150	4,62	2,91	2,1	0,05
4000	3,58	2,42	2,2	0,06
5000	2,87	2,02	2,4	0,07

f(Hz)	A <sub>obj</sub> [m <sup>2</sup> ]
125	0,5
250	1,0
500	1,4
1000	1,5
2000	1,8
4000	2,2

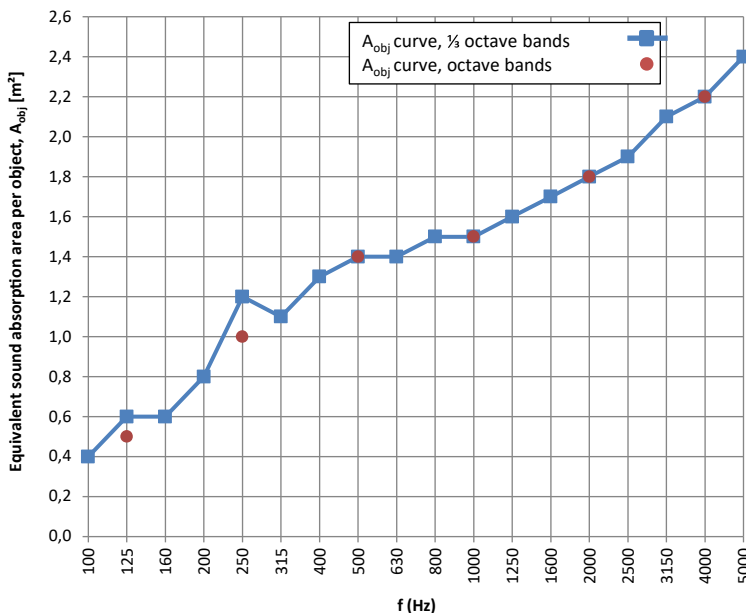

Note: an individual object is not evaluated according to ISO 11654 (α<sub>w</sub> and class)

**Requested by:** Deltalight, Muizelstraat 2, B-8560 Wevelgem (Moorsele)  
**TESTELEMANT:** (for details see Annex 2)



**Daidalos Peutz** bouwfysisch ingenieursbureau  
Vital Decosterstraat 67A – bus 1  
B-3000 Leuven  
Belgium  
VAT: BE 0454.276.239  
[www.daidalospeutz.be](http://www.daidalospeutz.be)



N° 451-TEST  
NBN EN ISO 17025:2017  
EA MLA signatory

**NOISE LAB**  
**REPORT Number A-2021LAB-061-18-20-44342\_E**

**ANNEX 1 : PRECISION**

The relative standard deviation of the reverberation time T20

$\epsilon_{20}$  = The relative standard deviation of the reverberation time T20, evaluated over a 20dB decay range, can be estimated by the following formula (see 8.2.2. van ISO 354:2003)

$$\epsilon_{20}(T) = T \sqrt{\frac{2,42 + 3,59/N}{f T}}$$

T<sub>1</sub> (s) = reverberation time of the empty room  
T<sub>2</sub> (s) = reverberation time of the reverberation room after with the test specimen  
f (Hz) = centre frequency of the one-third-octave band  
N = number of decay curves evaluated

The relative standard deviation of the sound absorption coefficient

$\epsilon(A_{obj})$  = The relative standard deviation of The relative standard deviation of the sound absorption coefficient

$$\epsilon(A_{obj}) = \frac{55,3 V}{c S} \sqrt{\left(\frac{\epsilon_{20}(T_2)}{T_2^2}\right)^2 + \left(\frac{\epsilon_{20}(T_1)}{T_1^2}\right)^2}$$

$\delta_{95}(A_{obj})$  = 95% confidence interval      95% confidence interval

$$\delta_{95}(A_{obj}) = \frac{1,96 \epsilon(\alpha)}{\sqrt{N}}$$

T<sub>1</sub> (s) = reverberation time of the empty room  
T<sub>2</sub> (s) = reverberation time of the reverberation room after with the test specimen  
V = Volume of the reverberation room  
c = the propagation speed of sound in air  
  
N = number of decay curves evaluated  
S = the area, in square metres, covered by the test specimen



Daidalos Peutz bouwfysisch ingenieursbureau  
Vital Decosterstraat 67A – bus 1  
B-3000 Leuven  
Belgium  
VAT: BE 0454.276.239  
[www.daidalospeutz.be](http://www.daidalospeutz.be)



N° 451-TEST  
NBN EN ISO 17025:2017  
EA MLA signatory

**NOISE LAB**  
**REPORT Number A-2021LAB-061-18-20-44342\_E**

**ANNEX 2: Description test items by manufacturer**

The test sample description given by manufacturer is checked visually as good as possible by the laboratory.  
The correspondence between the test element and the commercialized product is the sole responsibility of the manufacturer

**Zoover 140**

Material: PET felt  
Diameter of the panel: 1400 mm  
Thickness of the panel: 7 mm  
Height of the panel: 200 mm  
Weight tolerance: 2905gr - 10% + 13% (Min. 2614gr. Max. 3283gr)  
Height of the wooden frame (suspension height of the panel): 5 cm, 50 cm and 100 cm

Photo: Zoover 140 panel with light



Photo: Back side of Zoover 140 panel



Photo of the light





**Daidalos Peutz** bouwfysisch ingenieursbureau  
Vital Decosterstraat 67A – bus 1  
B-3000 Leuven  
Belgium  
VAT: BE 0454.276.239  
[www.daidalospeutz.be](http://www.daidalospeutz.be)



N° 451-TEST  
NBN EN ISO 17025:2017  
EA MLA signatory

**NOISE LAB**  
**REPORT Number A-2021LAB-061-18-20-44342\_E**

**ANNEX 3: Technical datasheet**

The test sample description given by manufacturer is checked visually as good as possible by the laboratory.  
The correspondence between the test element and the commercialized product is the sole responsibility of the manufacturer

Further information can be obtained from the manufacturer



**Daidalos Peutz** bouwfysisch ingenieursbureau  
Vital Decosterstraat 67A – bus 1  
B-3000 Leuven  
Belgium  
VAT: BE 0454.276.239  
[www.daidalospeutz.be](http://www.daidalospeutz.be)



**N° 451-TEST**  
NBN EN ISO 17025:2017  
EA MLA signatory

**NOISE LAB**  
**REPORT Number A-2021LAB-061-18-20-44342\_E**

**ANNEX 4A: technical drawings of the test element or the test arrangement**

*Description of the assembly or drawing or photo*

**Technical drawing:**

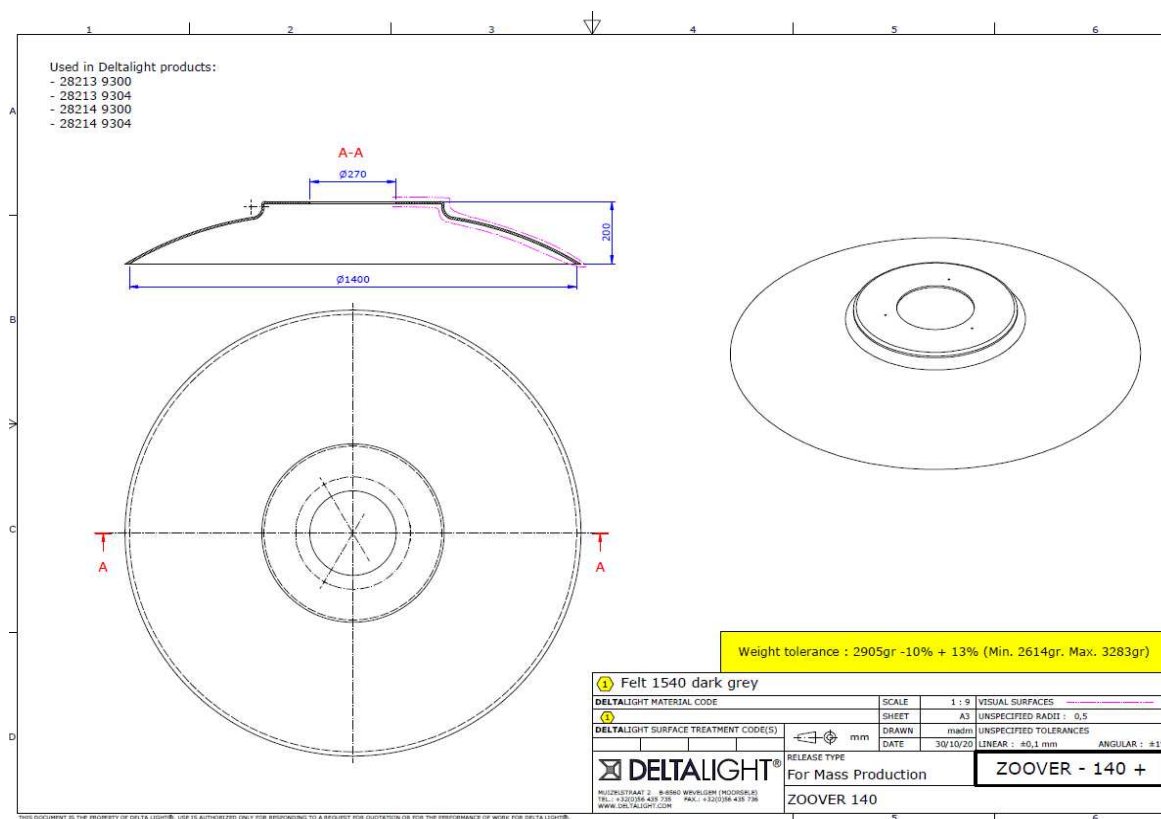



**Daidalos Peutz** bouwfysisch ingenieursbureau  
Vital Decosterstraat 67A – bus 1  
B-3000 Leuven  
Belgium  
VAT: BE 0454.276.239  
[www.daidalospeutz.be](http://www.daidalospeutz.be)



N° 451-TEST  
NBN EN ISO 17025:2017  
EA MLA signatory

**NOISE LAB**  
**REPORT Number A-2021LAB-061-18-20-44342\_E**

**ANNEX 4B: photographs of the test element or the test arrangement**

*Description of the assembly or drawing or photo*

Three configurations were tested:  
Zoover 140 with suspension height 5 cm, 50 cm and 100 cm  
Per configuration, 3 panels were placed in the reverberation room.

The test specimen comprise a sufficient number of individual objects (3 panels) to provide a measurable change in the equivalent sound absorption area of the room AT greater than  $1,31 \text{ m}^2 (V/200\text{m}^3)^{2/3}$

AT (100 Hz - 5000 Hz) with Zoover 140, height 5 cm = 4,07 m2

AT (100 Hz - 5000 Hz) with Zoover 140, height 50 cm = 4,27 m2

AT (100 Hz - 5000 Hz) with Zoover 140, height 100 cm = 4,28 m2

The objects were arranged randomly, spaced at least 2m apart and 1m away to any other boundary.

**Photos top to bottom from measurement nr 18:**  
Zoover 140 - height 5 cm

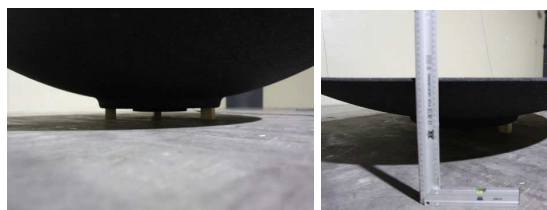
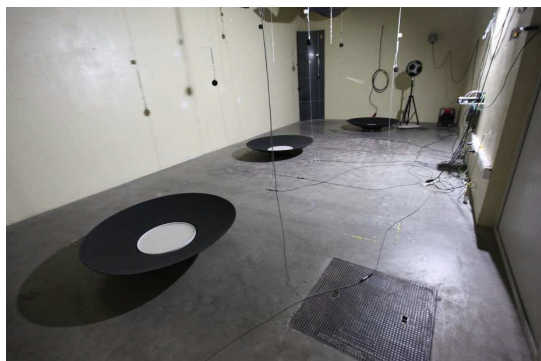

**Photos top to bottom from measurement nr 19:**  
Zoover 140 - height 50 cm







**Daidalos Peutz** bouwfysisch ingenieursbureau  
Vital Decosterstraat 67A – bus 1  
B-3000 Leuven  
Belgium  
VAT: BE 0454.276.239  
[www.daidalospeutz.be](http://www.daidalospeutz.be)



**N° 451-TEST**  
NBN EN ISO 17025:2017  
EA MLA signatory

**NOISE LAB**  
**REPORT Number A-2021LAB-061-18-20-44342\_E**

**ANNEX 4B: photographs of the test element or the test arrangement**

*Description of the assembly or drawing or photo*

Three configurations were tested:  
Zoover 140 with suspension height 5 cm, 50 cm and 100 cm  
Per configuration, 3 panels were placed in the reverberation room.

The test specimen comprise a sufficient number of individual objects (3 panels) to provide a measurable change in the equivalent sound absorption area of the room AT greater than  $1,31 \text{ m}^2 (V/200\text{m}^3)^{2/3}$   
AT (100 Hz - 5000 Hz) with Zoover 140, height 5 cm = 4,07 m<sup>2</sup>  
AT (100 Hz - 5000 Hz) with Zoover 140, height 50 cm = 4,27 m<sup>2</sup>  
AT (100 Hz - 5000 Hz) with Zoover 140, height 100 cm = 4,28 m<sup>2</sup>  
The objects were arranged randomly, spaced at least 2m apart and 1m away to any other boundary.

**Photos top to bottom from measurement nr 20:**  
Zoover 140 - height 100 cm





**Daidalos Peutz** bouwfysisch ingenieursbureau  
Vital Decosterstraat 67A – bus 1  
B-3000 Leuven  
Belgium  
VAT: BE 0454.276.239  
[www.daidalospeutz.be](http://www.daidalospeutz.be)



**N° 451-TEST**  
NBN EN ISO 17025:2017  
EA MLA signatory

**NOISE LAB**  
**REPORT Number A-2021LAB-061-18-20-44342\_E**

**ANNEX 5: Sketch of the test room**

The test room was built and finished according ISO 354.

**Reverberation Room (according EN ISO 354)**

