

SUPERNOVA FLAT 6583 DOWN-UP

DEEL
PARTIE
TEIL
PART
PARTE
PARTE

A

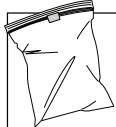
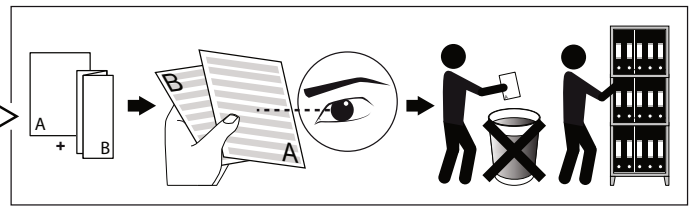
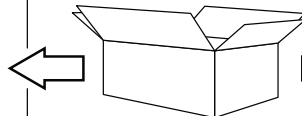
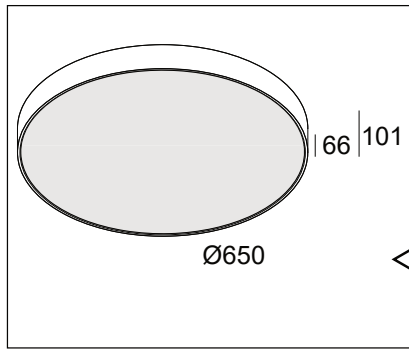

P_o	68W @ 1400mA DOWN / 22W UP @ 500mA	P_{Tot}	90W
U	220-240V / 0 50-60Hz		

REQUIRED

Central rod susp. Supernova flat 1m	274 97 10
or	
Central susp. Supernova flat 3m	328 26 23
or	
Suspension set 25 3m	328 25 43

OPTIONS SUSPENDED FIXATION

Cable Base R	203 99 55
Cable Base S	203 99 56
Coverset R 100	204 00 100
Coverset R 90	204 00 90
Coverset R 62	204 00 62
Coverset S 62	204 62 62
Coverset S 80	204 80 80
Coverset S 90	204 90 90

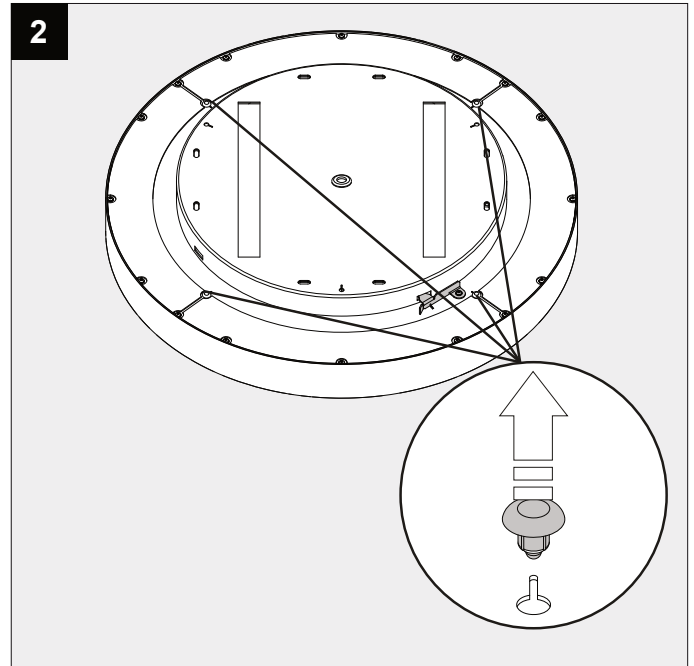
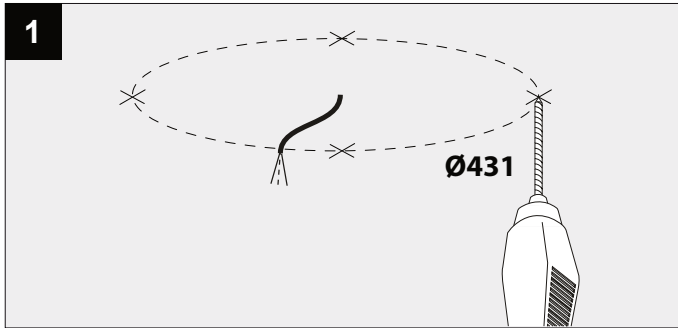

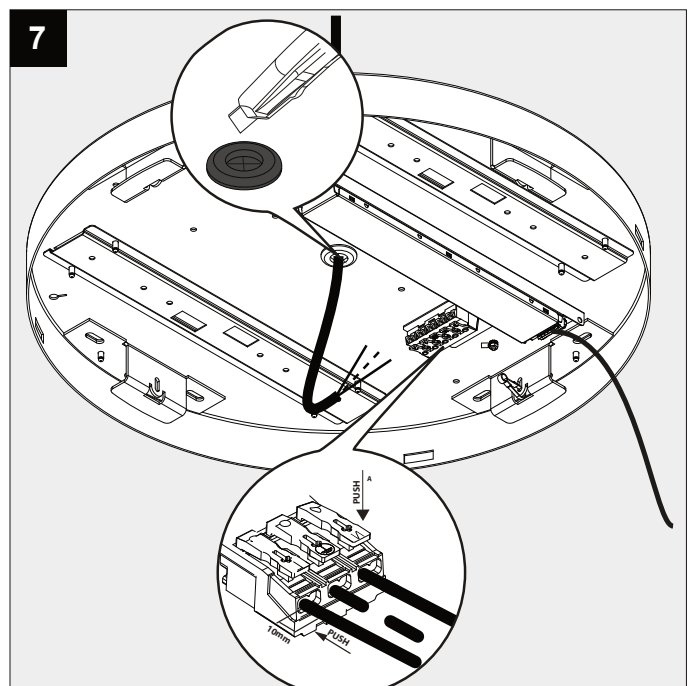
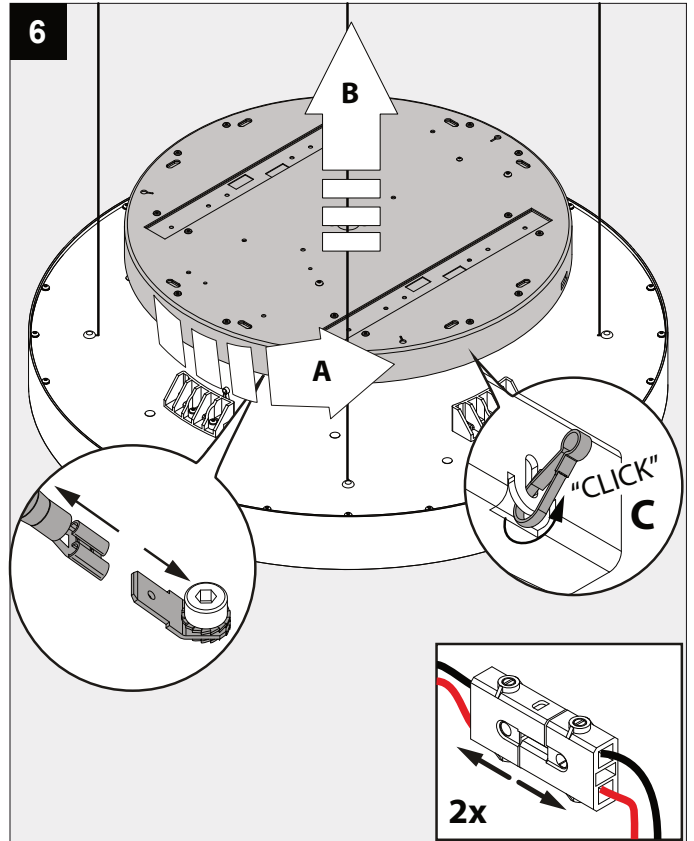
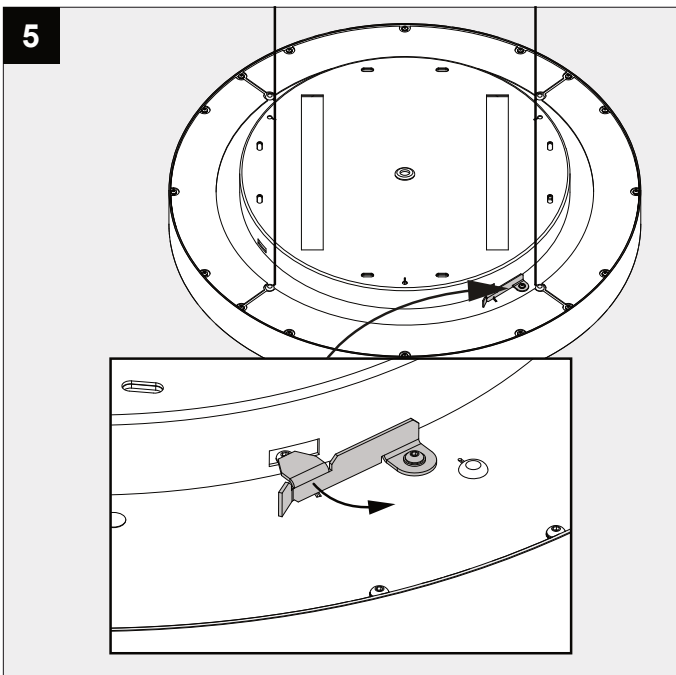
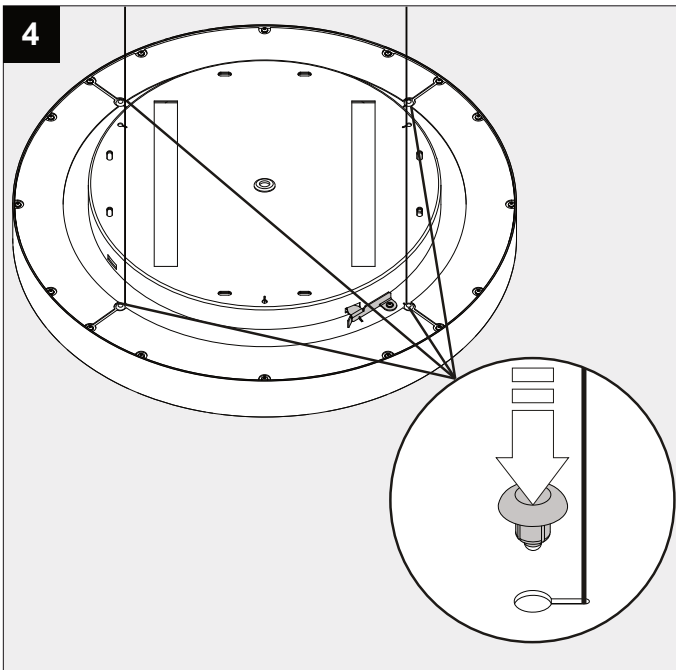
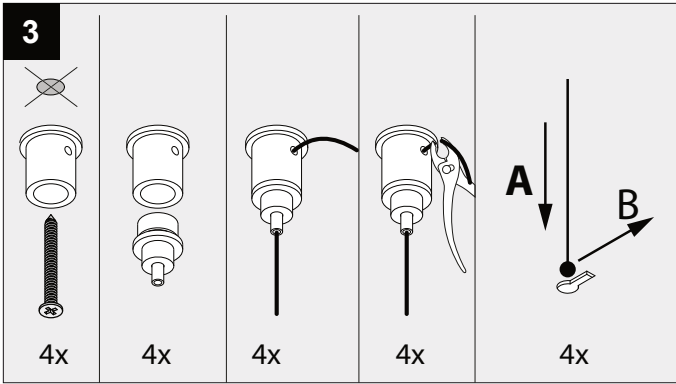

DIP SWITCH position (Only suitable for downlight)

SEC	4	3	2	1	SEC	4	3	2	1
350mA	-	-	-	-	910mA	-	-	-	ON
420mA	ON	-	-	-	930mA	ON	-	-	ON
450mA	-	ON	-	-	1050mA	-	ON	-	ON
500mA	ON	ON	-	-	1130mA	ON	ON	-	ON
650mA	-	-	ON	-	1150mA	-	-	ON	ON
700mA	ON	-	ON	-	1200mA	ON	-	ON	ON
750mA	-	ON	ON	-	1300mA	-	ON	ON	ON
840mA	ON	ON	ON	-	1400mA	ON	ON	ON	ON

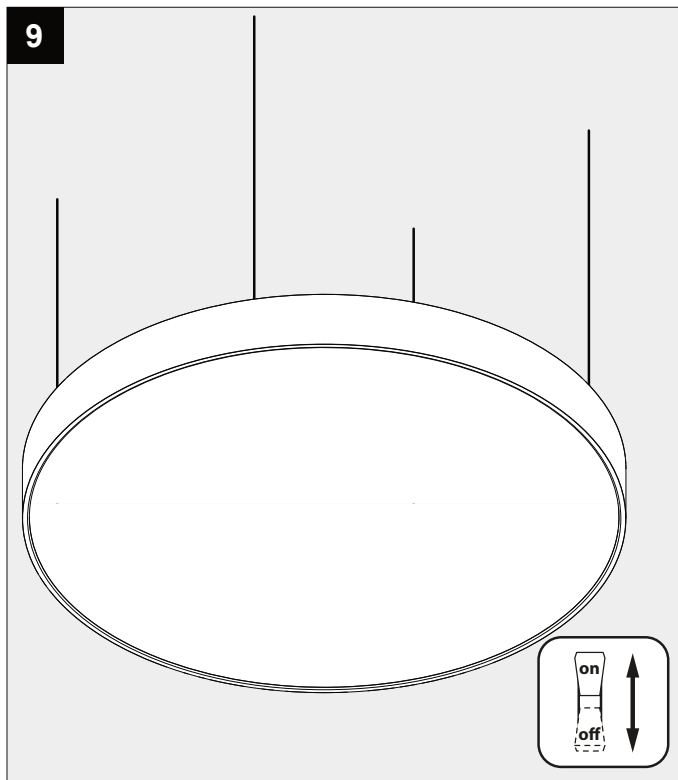
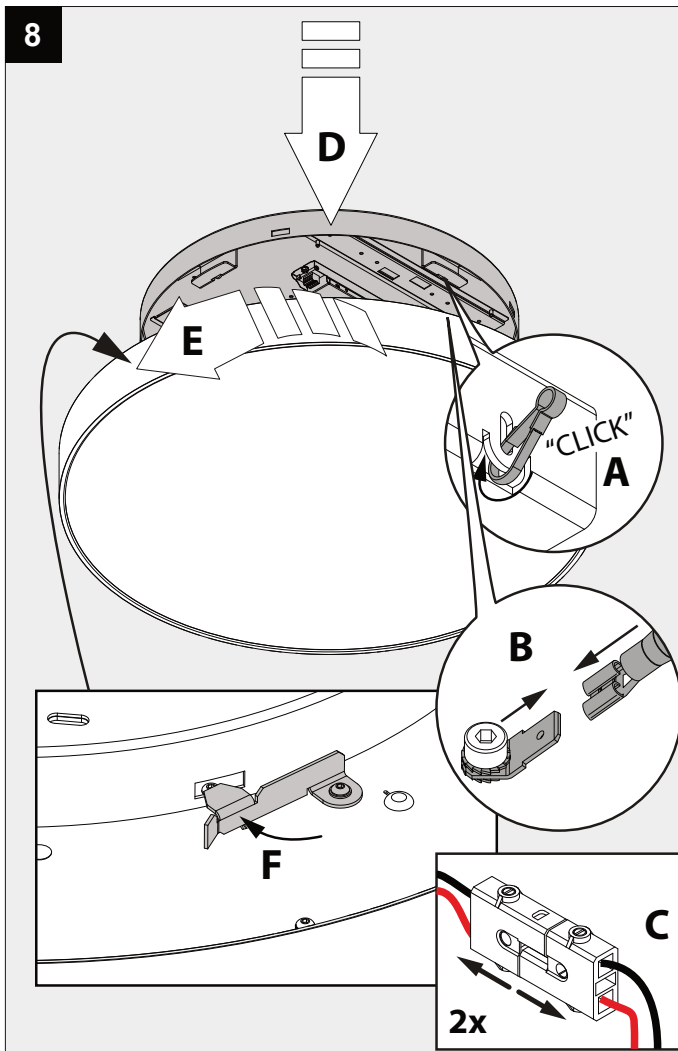

De verlichtingsbron van dit verlichtingstoestel zal enkel door de fabrikant of door de fabrikant aangestelde installateur vervangen worden.

La source lumière de cet appareil ne sera remplacée que par l'entreprise ou par un agent reconnu.

Das enthaltene Leuchtmittel sollte nur durch entsprechendes Fachpersonal ersetzt werden.

The light source contained in this luminaire shall only be replaced by the manufacturer or his service agent.

La fuente de iluminación que tiene esta luminaria sólo puede remplazarse por el fabricante o por un instalador autorizado.

La sorgente luminosa incorporata in questo apparecchio può essere sostituita solo dal produttore, da un suo centro assistenza oppure da una persona in possesso della necessaria abilitazione.

 Voorzien van aardingsaansluiting
Avec mise à terre
Ausgerüstet mit Erdungsanschluss
Provided with grounding
Con la toma de tierra
Con presa a terra

 IP20
Beschermd tegen vaste voorwerpen die groter zijn dan 12 mm
Protégé contre les objets solides de plus de 12 mm
Geschützt gegen Festkörper größer als 12 mm
Protected against solid objects greater than 12 mm
Protegido contra objetos sólidos superiores a 12 mm
Protetto contro oggetti solidi più grandi di 12 mm

 This product contains a light source of energy efficiency class E
本产品包含能效等级为 E 的光源
Этот артикул содержит источник света с энергоэффективностью класса E
يحتوي هذا المنتج على مصدر ضوء ذو كفاءة الطاقة E
Dit product bevat een verlichtingsbron van energie-efficiëntieklasse E
Ce produit contient une source d'éclairage de classe d'efficacité énergétique E
Dieses Produkt enthält eine Lichtquelle der Energieeffizienzklasse E
Este producto contiene una fuente de iluminación de clase de eficiencia energética E
Questo prodotto contiene una fonte di illuminazione in classe di efficienza energetica E

Replaceable (LED only) light source and control gear by a professional
(仅针对LED)光源及其控制设备只能由专业人员更换
(для СВЕТОДИОДНЫХ светильников) замена источника света и блока питания может быть произведена только квалифицированным специалистом
مصدر الضوء (ليد فقط) ومعدات التحكم قابلين للتغيير بإشراف الفني المتخصص
Verlichtingsbron (enkel LED) en voorschakelapparaat kan enkel vervangen worden door een professional
La source d'éclairage (uniquement LED) et le ballast ne peut être remplacé que par un professionnel
Die Lichtquelle (nur LED) und Vorschaltgerät kann nur von einem Fachmann ausgetauscht werden
La fuente de iluminación (solo LED) solo puede ser reemplazada por un profesional
La sorgente luminosa (LED) e l'alimentatore possono essere sostituiti solo da un professionista.