

**KIX HP PIN**

DEEL  
PARTIE  
TEIL  
PART  
PARTE  
PARTE **A**

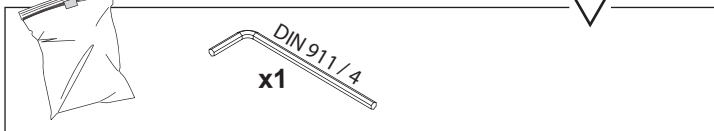
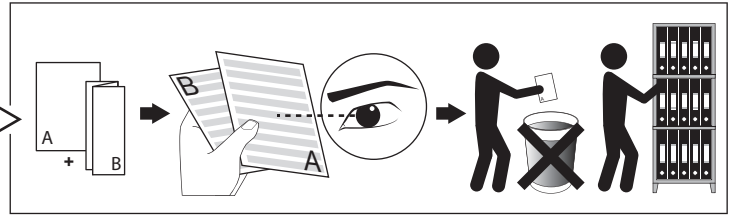
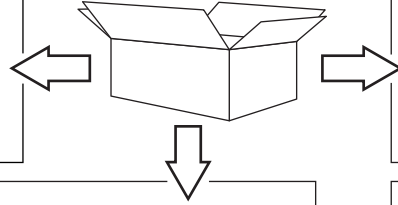
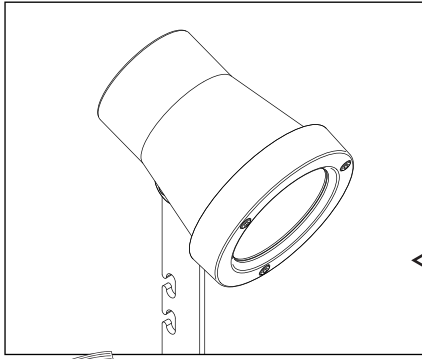

**IP65**  
 Stofdicht - Beschermd tegen waterstralen  
 Etanche aux poussières - Protégé contre les jets d'eau  
 Staubdicht - Geschützt gegen Wasserstrahl  
 Dust-tight - Protected against water jets  
 Hermético al polvo - Protegido contra chorros de agua  
 A tenuta di polvere - Protetto contro i getti d'acqua

Enkel geschikt voor toestellen op zeer lage spanning (minder dan 50 V AC)  
 Convient uniquement pour les produits à très basse tension (moins de 50 V AC)  
 Geeignet für Güter mit sehr niedriger Spannung (unter 50 V AC)  
 Only suited for goods at very low voltage (below 50 V AC)  
 Se recomienda únicamente para aquellos productos de tensión muy baja (menos de 50 V AC)  
 Vale unicamente per i prodotti a tensione molto bassa (inferiore a 50 V AC)

**OPTIONS**

- CBOX** 216 12 00
- IP68 CONNECTION KIT** 216 12 01
- IP68 CONNECTION 3P** 216 12 02

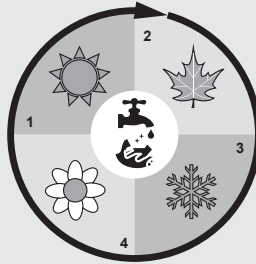

**CAUTION!**  
 CLEAN AT LEAST  
 QUATERLY WITH WATER  
 AND NON-ABRASIVE CLOTH

<b>I<sub>o</sub></b>	<b>500mA</b>
<b>P<sub>o</sub></b>	<b>16,8W</b>
<b>U<sub>f</sub> Typical</b>	<b>33,7V-DC</b>

**1**

**WATERPROOF CONNECTION**

**OPTION CBOX 216 12 00**

**OPTION IP68 CONNECTION KIT 216 12 01**  
**IP68 CONNECTOR 3P 216 12 02**

**ATTENTION**  
 OBSERVE PRECAUTIONS FOR HANDLING ELECTROSTATIC DISCHARGE SENSITIVE DEVICES  
 NO SECONDARY SWITCHING

**2**

**SERIES ELECTRICAL CONNECTION**

**DO NOT CONNECT IN PARALLEL!!!**

De verlichtingsbron van dit verlichtingstoestel zal enkel door de fabrikant of door de fabrikant aangestelde installateur vervangen worden.

La source lumière de cet appareil ne sera remplacée que par l'entreprise ou par un agent reconnu.

Das enthaltene Leuchtmittel sollte nur durch entsprechendes Fachpersonal ersetzt werden.

The light source contained in this luminaire shall only be replaced by the manufacturer or his service agent.

La fuente de iluminación que tiene esta luminaria sólo puede remplazarse por el fabricante o por un instalador autorizado.

La sorgente luminosa incorporata in questo apparecchio può essere sostituita solo dal produttore, da un suo centro assistenza oppure da una persona in possesso della necessaria abilitazione.

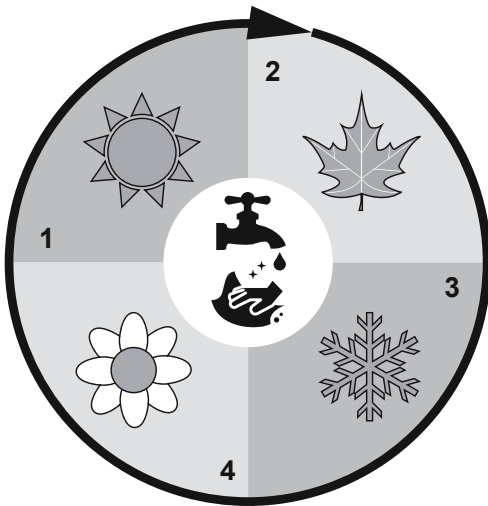

**CAUTION! CLEAN AT LEAST QUARTERLY WITH WATER AND NON-ABRASIVE CLOTH**

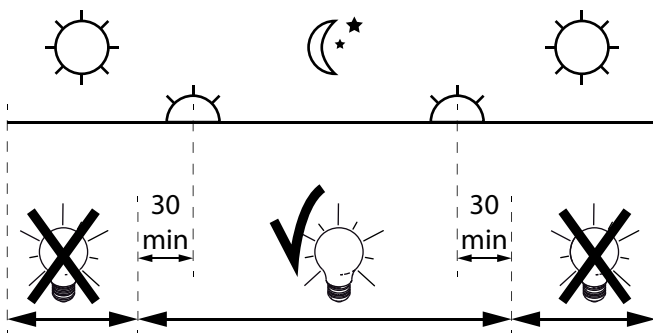

Dagelijkse ontstekingsperiode toegestaan  
 Durée quotidienne d'allumage admissible  
 Erlaubte tägliche einschaltdauer  
 Allowed daily operation period  
 Period giornaliero di accensione ammesso  
 Periodo diario de encendido permitido