

**SLM26H - POWERBOX 48V-DC / 96W**

DEEL  
PARTIE  
TEIL  
PART  
PARTE  
PARTE

**A**

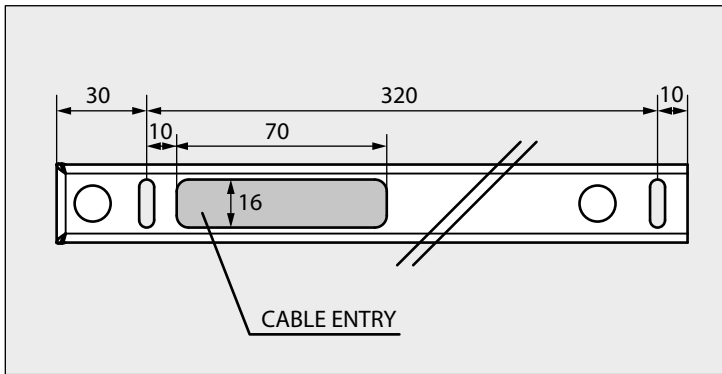
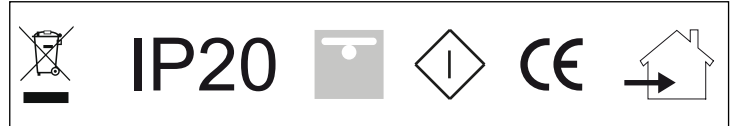
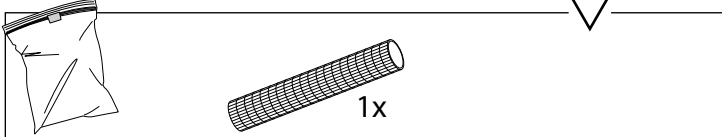
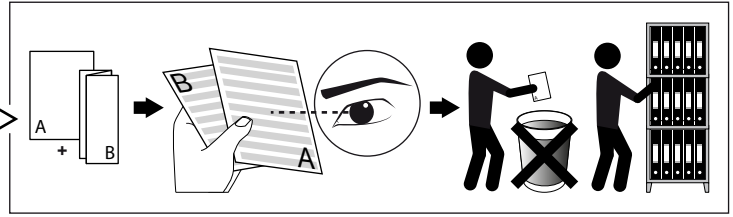
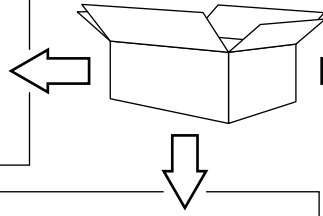
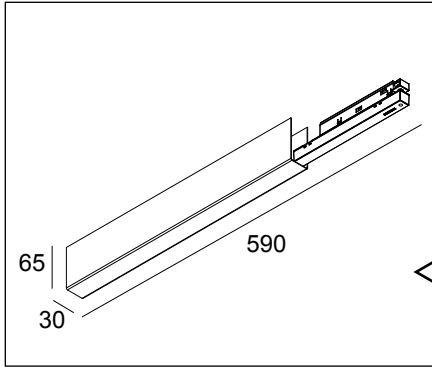

**REQUIRED**  
**SLM26L - PROFILE**      **23358 0000**

**U**      **220-240V**

**IP20**  
Beschermd tegen vaste voorwerpen die groter zijn dan 12 mm  
Protégé contre les objets solides de plus de 12 mm  
Geschützt gegen Festkörper größer als 12 mm  
Protected against solid objects greater than 12 mm  
Protegido contra objetos sólidos superiores a 12 mm  
Protetto contro oggetti solidi più grandi di 12 mm

 Voorzien van aardingsaansluiting  
Avec mise à la terre  
Ausgerüstet mit Erdungsanschluss  
Provided with grounding  
Con la toma de tierra  
Con presa a terra

