

MILES C4

DEEL
PARTIE
TEIL
PART
PARTE
PARTE **A**

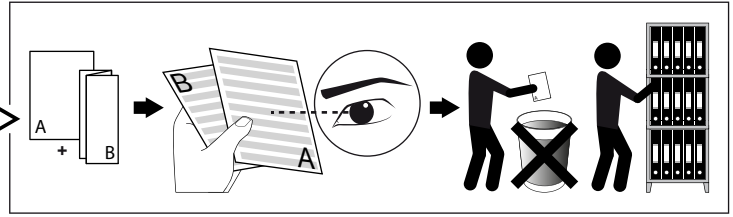
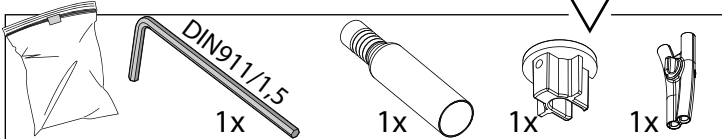

REQUIRED

CEILING BASE	23943 0010
OR	
POWERBOX 350mA DIM8	23942 0018
OR	
MILES CEILING BASE 3L	23945 0010
OR	
MILES CEILING BASE 3R	23945 0020

ACCESSORIES

MILES TUBE	23944 0010
------------	------------

AVAILABLE COLORS

MILES C4 PINK	23938 9230
MILES C4 SMOKE	23939 9230
MILES C4 MIST	23940 9230
MILES C4 AMBER	23941 9230

P_o	7,1 W
I	350 mA
U_{typ}	20,2 V - DC

IP20

Beschermd tegen vaste voorwerpen die groter zijn dan 12 mm
 Protégé contre les objets solides de plus de 12 mm
 Geschützt gegen Festkörper größer als 12 mm
 Protected against solid objects greater than 12 mm
 Protegido contra objetos sólidos superiores a 12 mm
 Protetto contro oggetti solidi più grandi di 12 mm

Enkel geschikt voor toestellen op zeer lage spanning (minder dan 50 V-AC / 120 V-DC)
 Convient uniquement pour les produits à très basse tension (moins de 50 V-AC / 120 V-DC)
 Geeignet für Güter mit sehr niedriger Spannung (unter 50 V-AC / 120 V-DC)
 Only suited for goods at very low voltage (below 50 V-AC / 120 V-DC)
 Se recomienda únicamente para aquellos productos de tensión muy baja (menos de 50 V-AC / 120 V-DC)
 Vale unicamente per i prodotti a tensione molto bassa (inferiore a 50 V-AC / 120 V-DC)

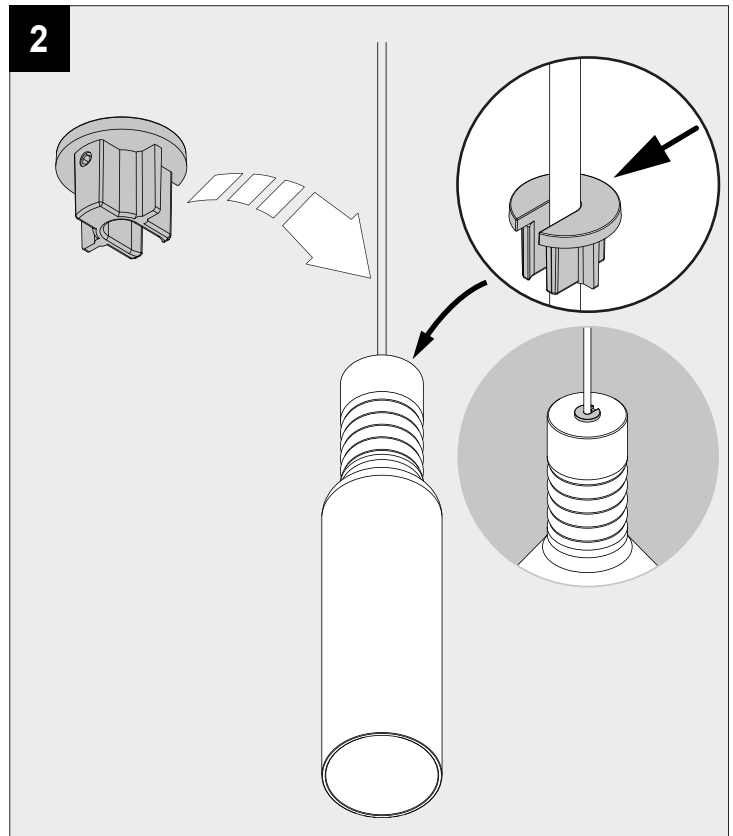
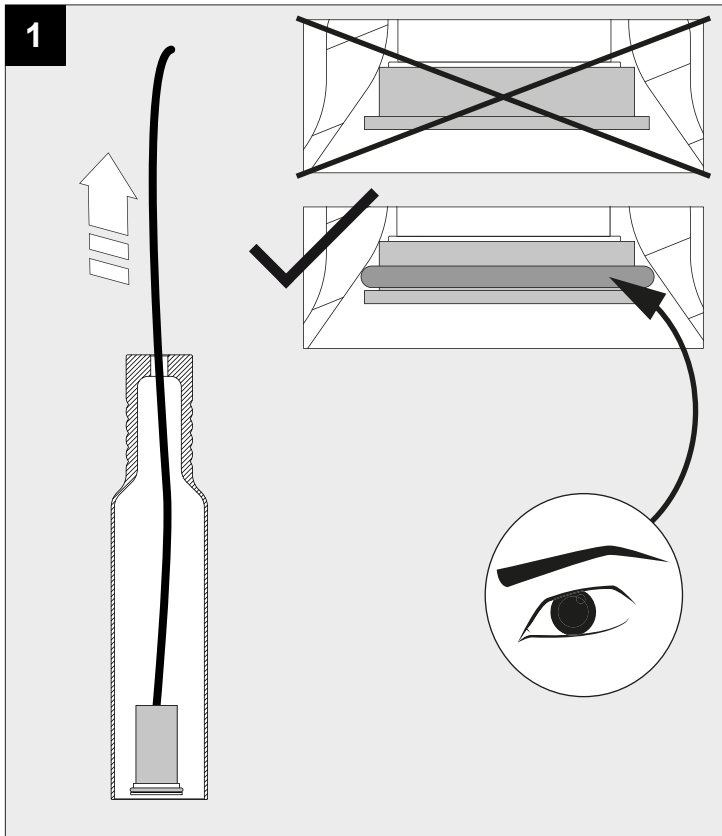

3 **OPTIONAL**

ACCESSORIES
MILES TUBE 23944 0010



4 **REQUIRED**

CEILING BASE 23943 0010

OR _____

POWERBOX 350mA DIM8 23942 0018

OR _____

MILES CEILING BASE 3L 23945 0010

OR _____

MILES CEILING BASE 3R 23945 0020

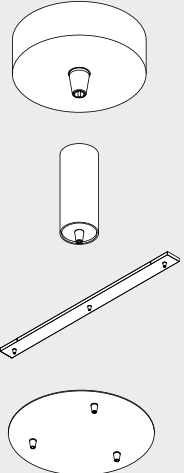

5

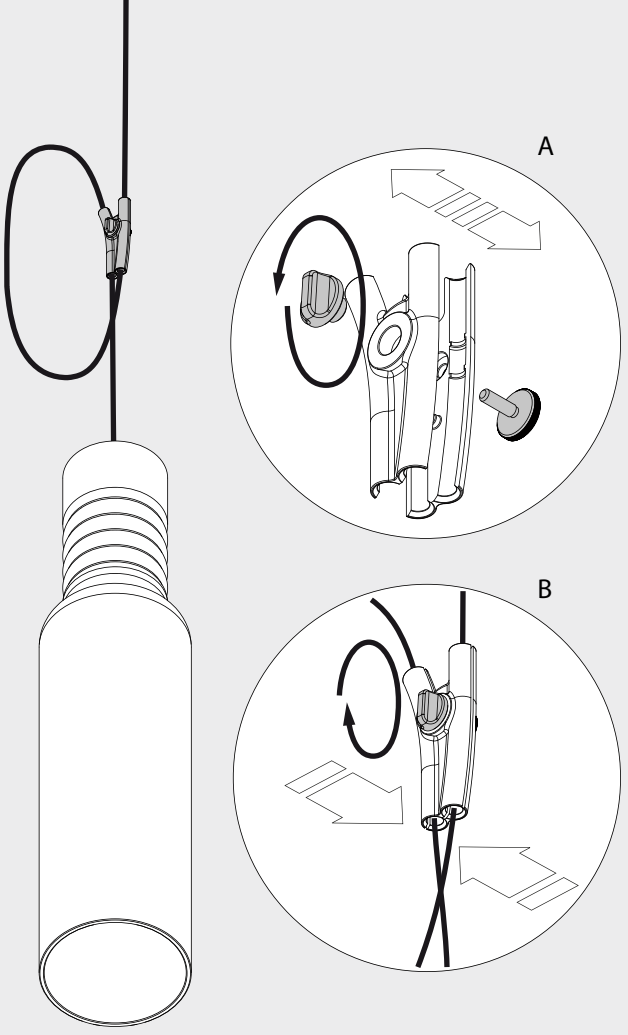

6

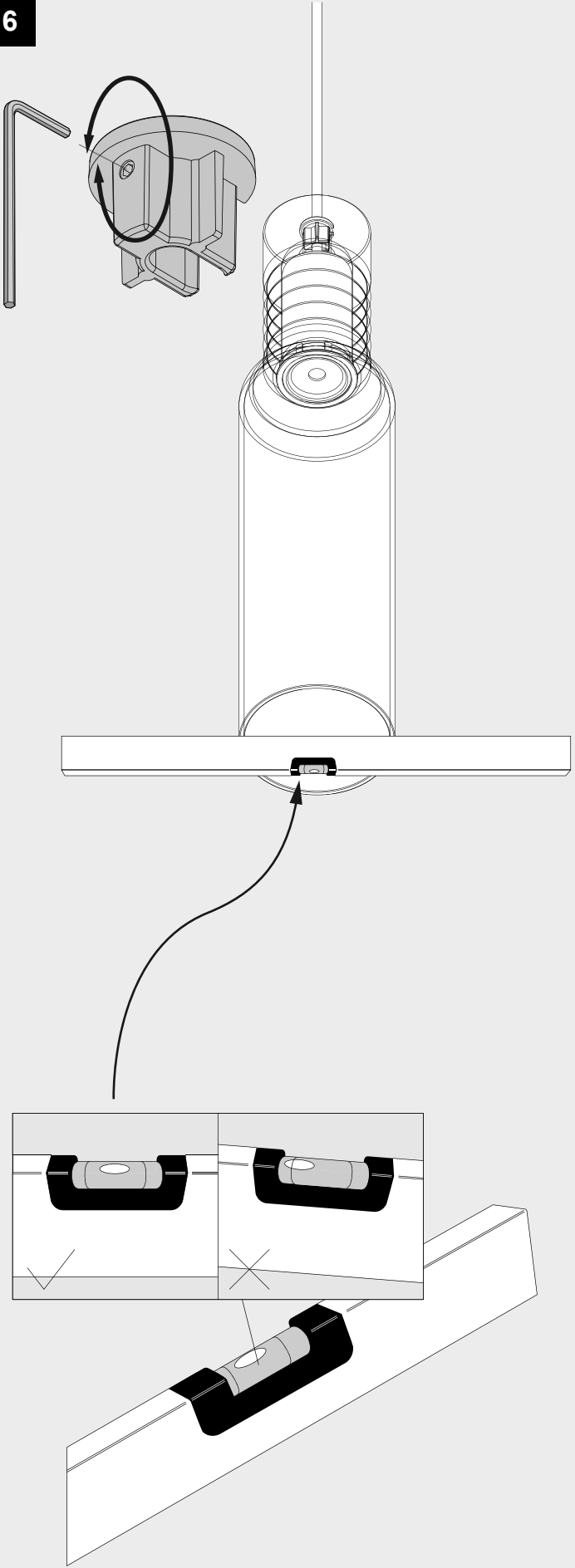

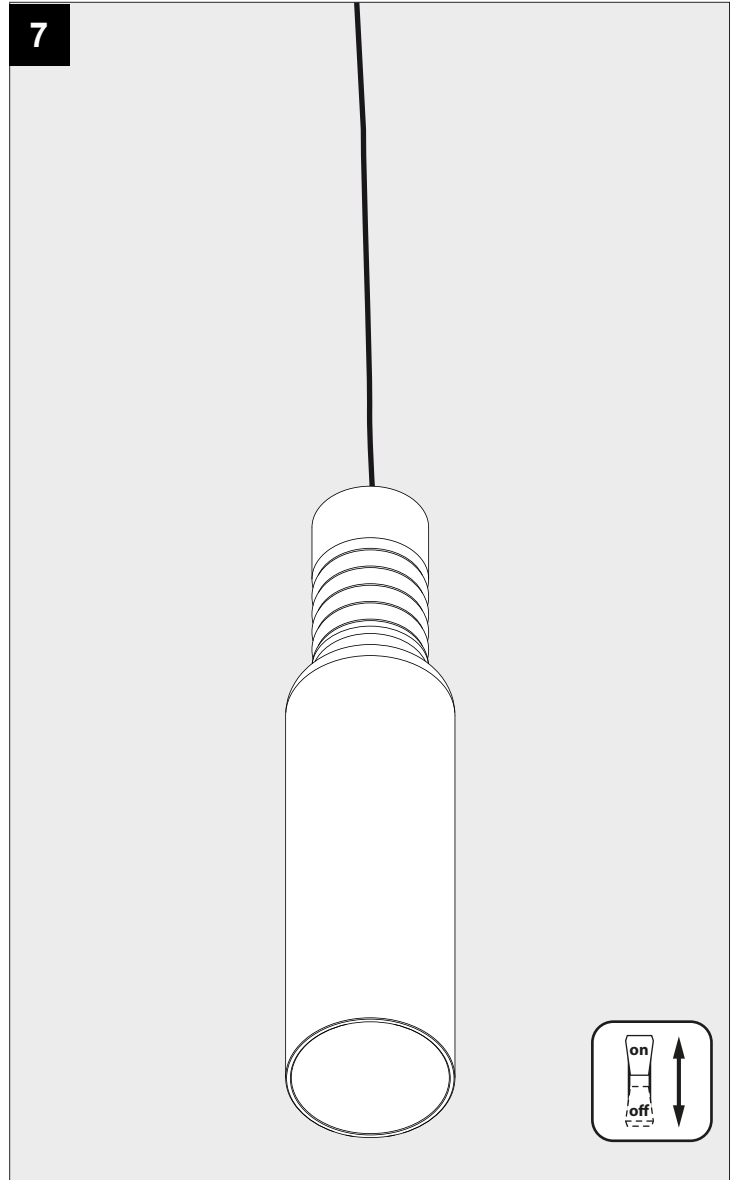
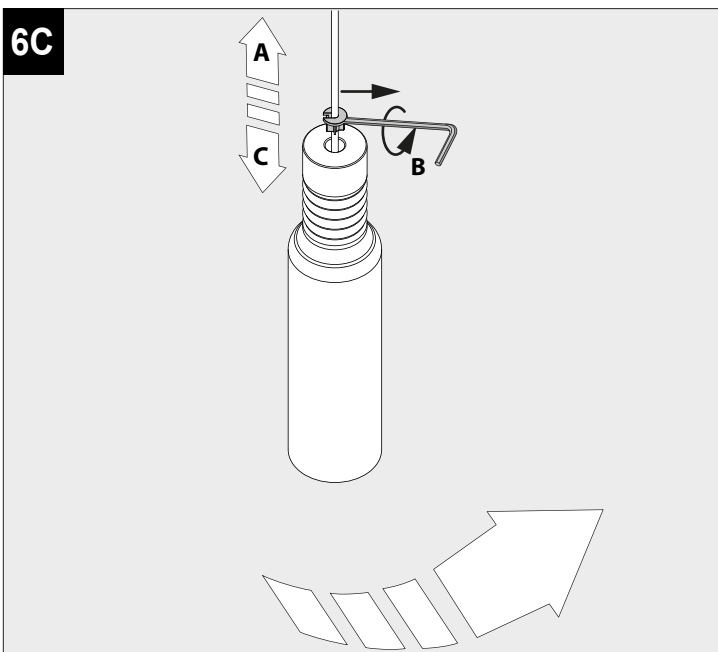
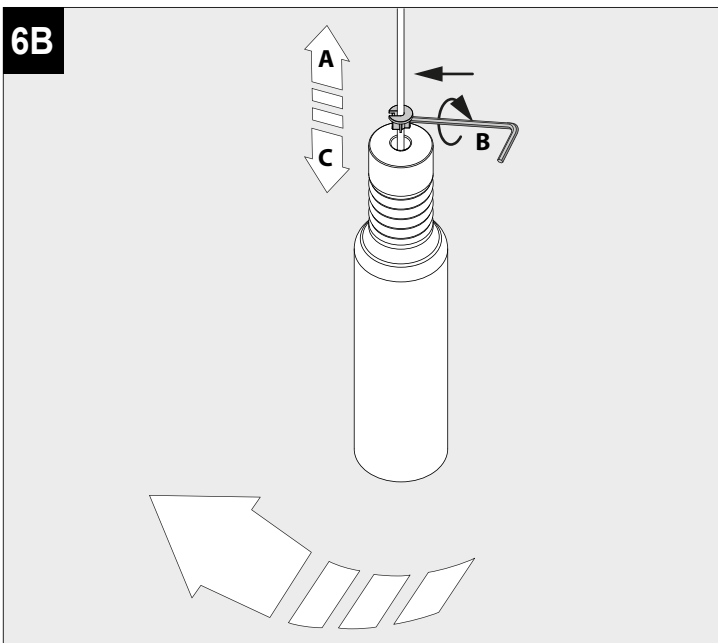
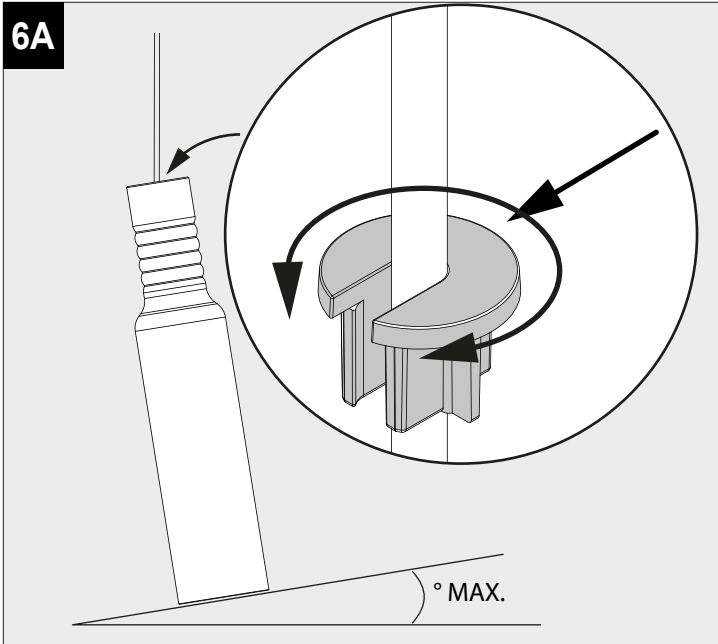

**CAUTION! CLEAN BY USING
A DAMP MICROFIBER
CLOTH IN A DELICATE WAY**

De verlichtingsbron van dit verlichtingstoestel zal enkel door de fabrikant of door de fabrikant aangestelde installateur vervangen worden.

La source lumière de cet appareil ne sera remplacée que par l'entreprise ou par un agent reconnu.

Das enthaltene Leuchtmittel sollte nur durch entsprechendes Fachpersonal ersetzt werden.

The light source contained in this luminaire shall only be replaced by the manufacturer or his service agent.

La fuente de iluminación que tiene esta luminaria sólo puede remplazarse por el fabricante o por un instalador autorizado.

La sorgente luminosa incorporata in questo apparecchio può essere sostituita solo dal produttore, da un suo centro assistenza oppure da una persona in possesso della necessaria abilitazione.