

D-LINER RM TYPE 2 15 DIM1

DEEL
PARTIE
TEIL
PART
PARTE
PARTE

A

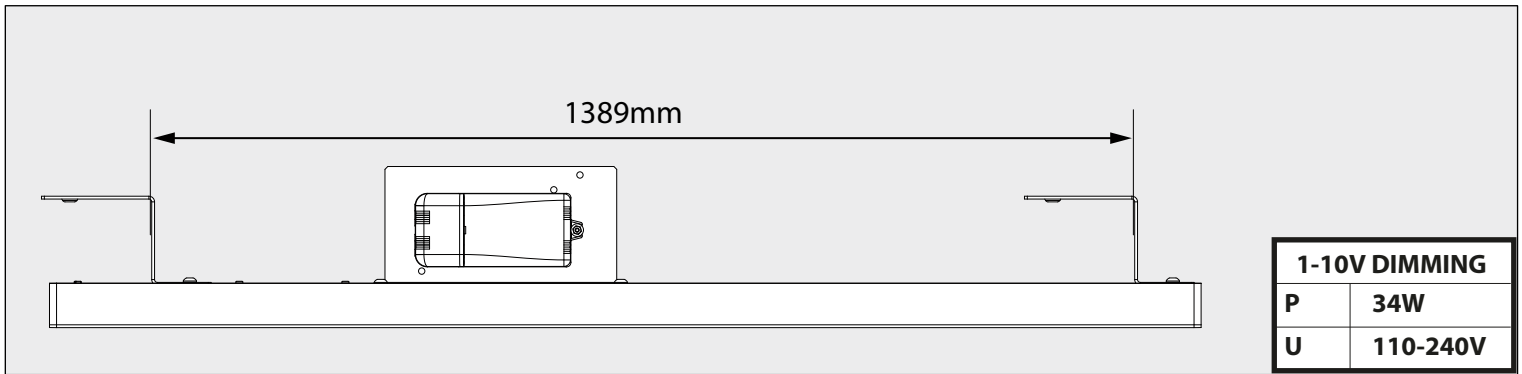
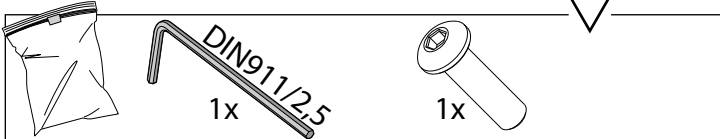
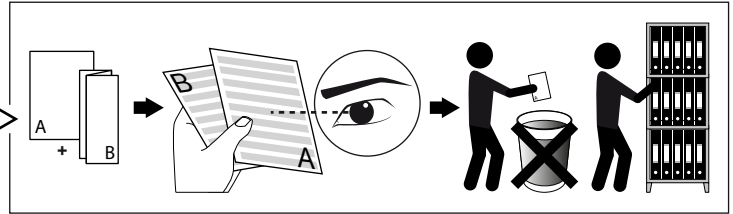
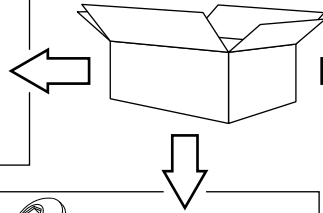
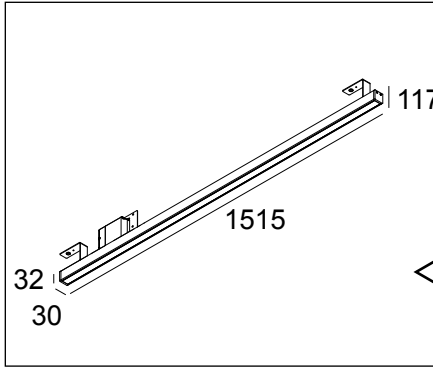

IP20
 Beschermd tegen vaste voorwerpen die groter zijn dan 12 mm
 Protégé contre les objets solides de plus de 12 mm
 Geschützt gegen Festkörper größer als 12 mm
 Protected against solid objects greater than 12 mm
 Protegido contra objetos sólidos superiores a 12 mm
 Protetto contro oggetti solidi più grandi di 12 mm

Goederen zijn dubbel geïsoleerd - geen aarding nodig
 Les produits ont une isolation double et ne peuvent pas être mis à la terre
 Güter sind doppelt isoliert und müssen nicht geerdet werden
 Goods have double insulation and must not be grounded
 Los productos tienen u aislamiento doble y no se pueden conectar a tierra
 I prodotti possiedono un doppio isolamento e non devono essere collegati a terra

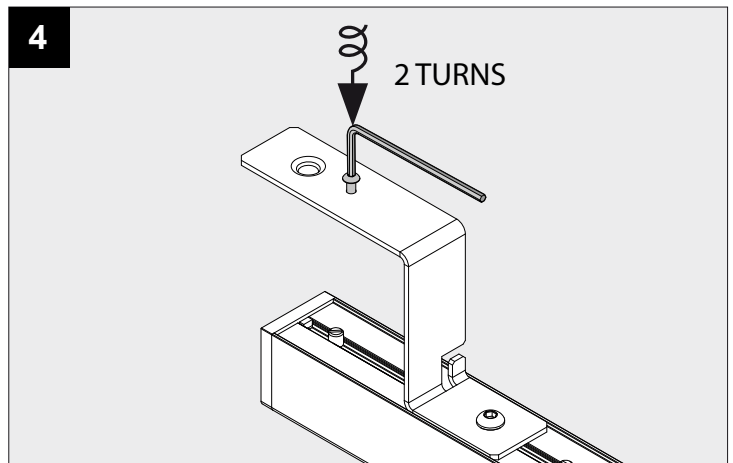
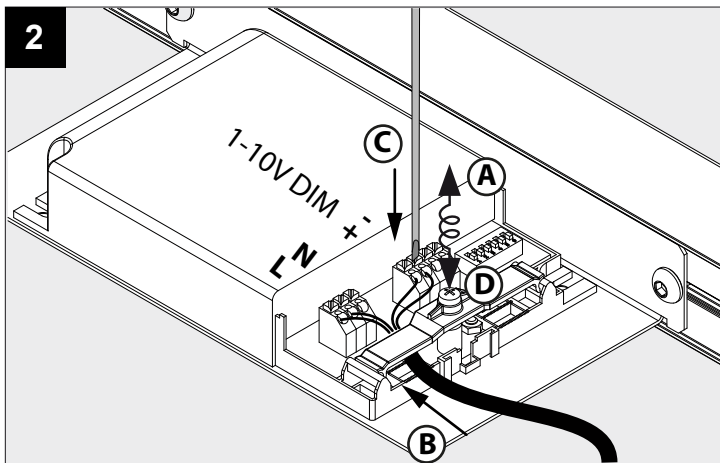
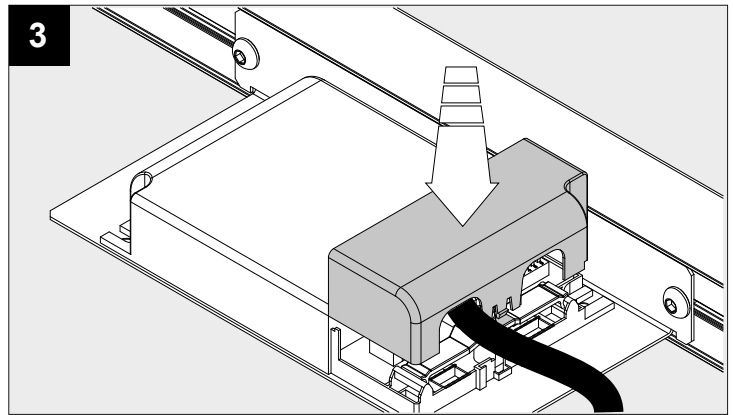
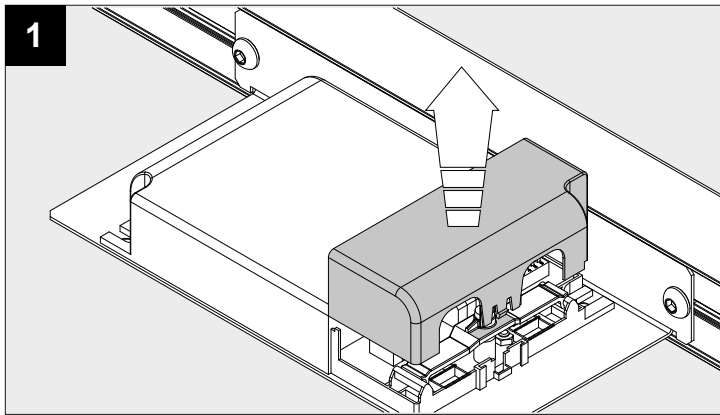

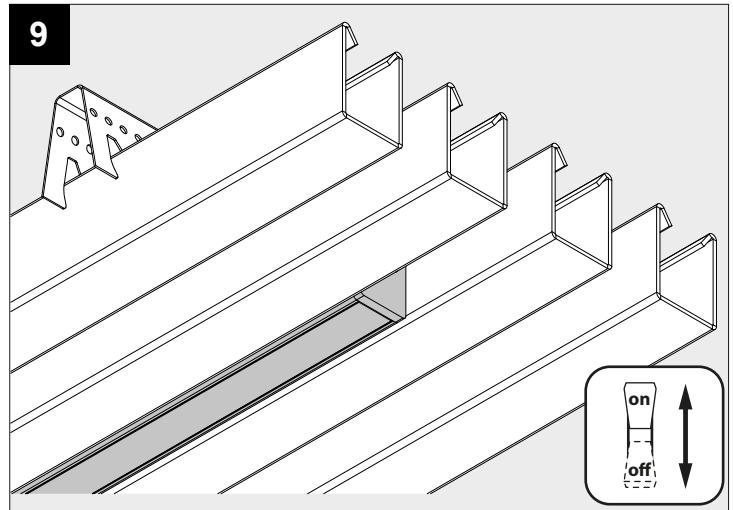
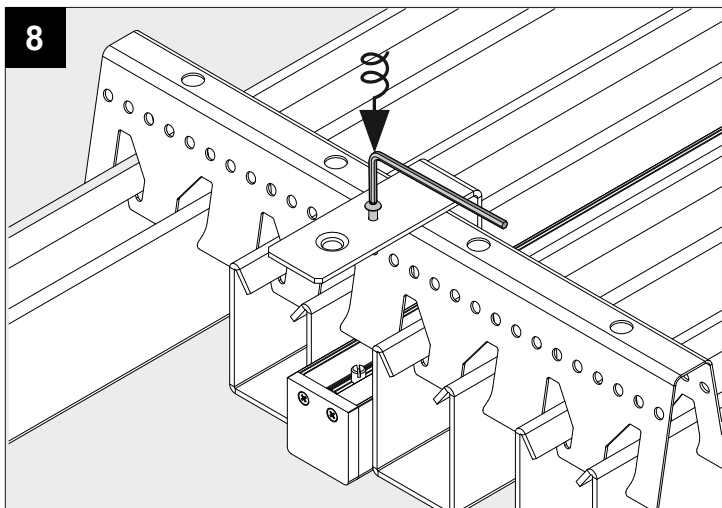
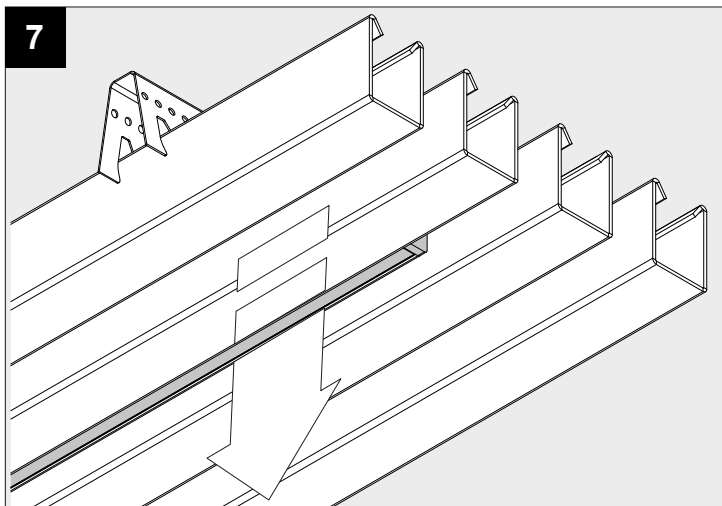
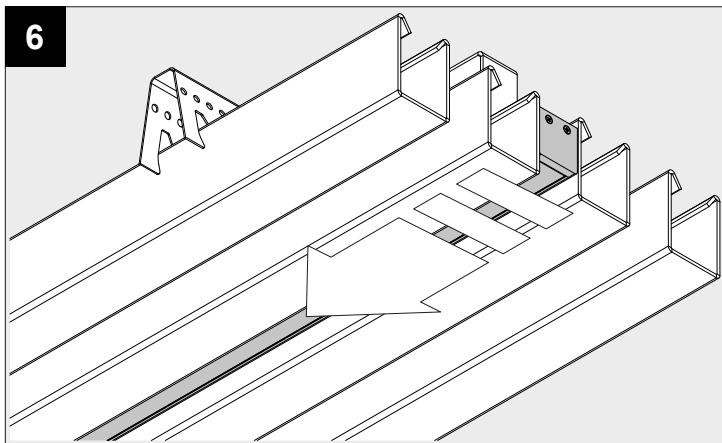
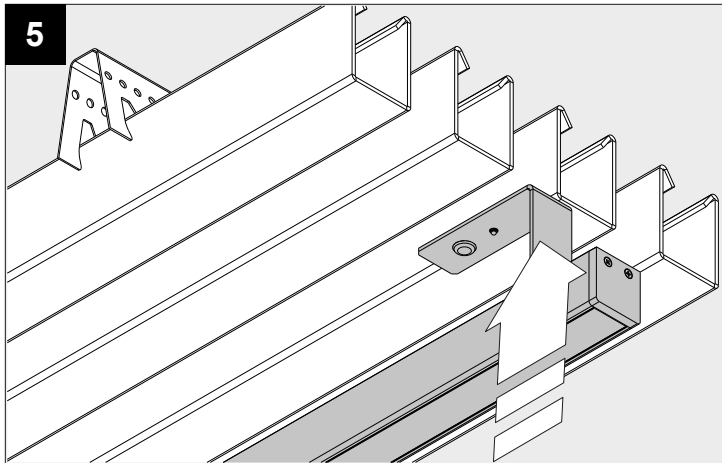

De verlichtingsbron van dit verlichtingstoestel zal enkel door de fabrikant of door de fabrikant aangestelde installateur vervangen worden.

La source lumière de cet appareil ne sera remplacée que par l'entreprise ou par un agent reconnu.

Das enthaltene Leuchtmittel sollte nur durch entsprechendes Fachpersonal ersetzt werden.

The light source contained in this luminaire shall only be replaced by the manufacturer or his service agent.

La fuente de iluminación que tiene esta luminaria sólo puede remplazarse por el fabricante o por un instalador autorizado.

La sorgente luminosa incorporata in questo apparecchio può essere sostituita solo dal produttore, da un suo centro assistenza oppure da una persona in possesso della necessaria abilitazione.