

1 RENDEZ-VOUS - ACCESSORY SET

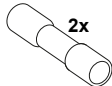

4x (IF USING RGB)

Ref.: 14 333 6200 00

2 RENDEZ-VOUS - CORNERS

EXAMPLE: CORNER 90° EXT

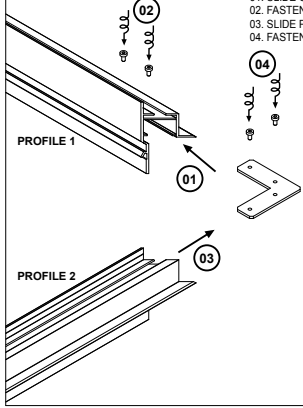

INSTALLATION INSTRUCTIONS
 01. SLIDE CORNER IN PROFILE 1
 02. FASTEN SCREWS
 03. SLIDE PROFILE 2 ON CORNER
 04. FASTEN SCREWS

CROSS SECTION

RV - CORNER 180°
333 06 01

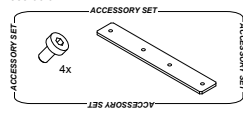

RV - CORNER 90° INT
333 06 06

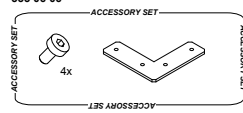

RV - CORNER 90° EXT
333 06 16

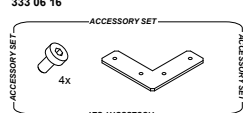

3 RENDEZ-VOUS - POSITIONS FOR INSTALLATION

DOWN

INSTALLATION INSTRUCTIONS

01. MAKE HOLE PATTERN
02. PLACE WALL FIXATION
03. PLACE PROFILE ON WALL FIXATION
04. FIX PROFILE
05. FINISH WALL

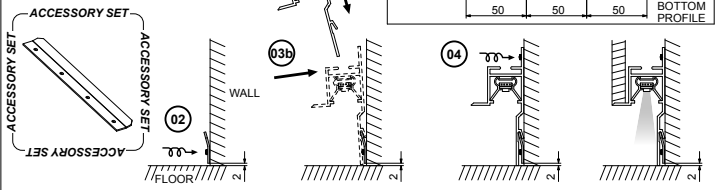

UP

INSTALLATION INSTRUCTIONS

01. MAKE HOLE PATTERN
02. PLACE WALL FIXATION
03. PLACE PROFILE ON WALL FIXATION
04. FIX PROFILE
05. FINISH WALL

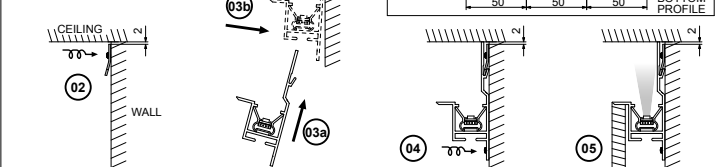

SIDE

INSTALLATION INSTRUCTIONS

01. MAKE HOLE PATTERN
02. PLACE WALL FIXATION
03. PLACE PROFILE ON WALL FIXATION
04. FIX PROFILE
05. FINISH WALL

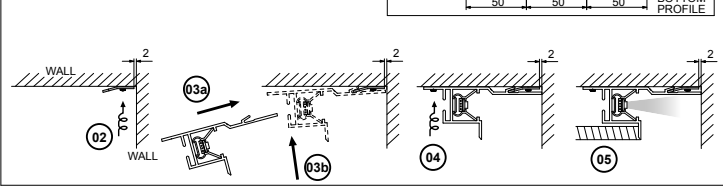

4 RENDEZ-VOUS - ELECTRICAL CONNECTION WITH WHITE LEDSTRIPS

LED Power Supply 24V-DC

LED POWER SUPPLY 24V-DC / 13W

300 89 24 13
110-240V / 50-60Hz FOR 110V DEVIDE ALL RATINGS BY 2.5

CE 0.1 IP20

OPTIONS
RGB CONTROLLER 12/24V-DC 75/150W DUAL MODE / RGB DRIVER / RGB TOUCH CONTROLLER DMX

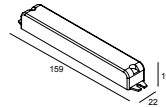
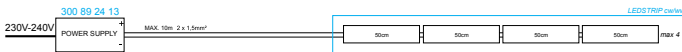

LED Power Supply 24V-DC

LED POWER SUPPLY 24V-DC / 20W

300 89 24 20
110-240V / 50-60Hz FOR 110V DEVIDE ALL RATINGS BY 2.5

CE 0.1 IP20

OPTIONS
RGB CONTROLLER 12/24V-DC 75/150W DUAL MODE / RGB DRIVER / RGB TOUCH CONTROLLER DMX

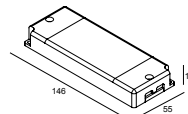

LED Power Supply 24V-DC

LED POWER SUPPLY 24V-DC / 40W

300 89 24 40
230-240V / 50-60Hz

CE 0.1 IP67

OPTIONS
RGB CONTROLLER 12/24V-DC 75/150W DUAL MODE / RGB DRIVER / RGB TOUCH CONTROLLER DMX

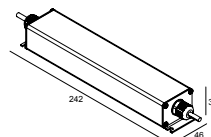

LED RGB KIT 20
300 90 202

INCL. 1 x LED POWER SUPPLY 24V-DC / 20W
 INCL. 1 x RGB DRIVER
 EXCL. 1 x RGB TOUCH CONTROLLER DMX

CE 3,4 IP20

OPTIONS
 RGB TOUCH CONTROLLER

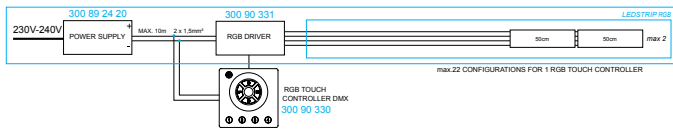

LED RGB Kit 60 - Installation Scheme

LED RGB KIT 60
300 90 206

INCL. 1 x LED POWER SUPPLY 24V-DC / 60W
 INCL. 1 x RGB DRIVER
 EXCL. 1 x RGB TOUCH CONTROLLER DMX

CE 3,4 IP20

OPTIONS
 RGB TOUCH CONTROLLER

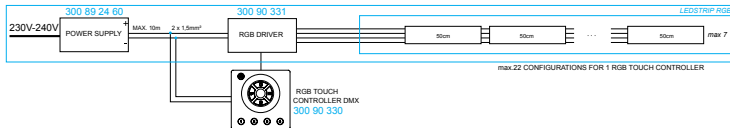

LED RGB Kit 150 - Installation Scheme

LED RGB KIT 150
300 90 215

INCL. 1 x LED POWER SUPPLY 24V-DC / 150W
 INCL. 1 x RGB DRIVER
 EXCL. 1 x RGB TOUCH CONTROLLER DMX

CE 3,4 IP20

OPTIONS
 RGB TOUCH CONTROLLER

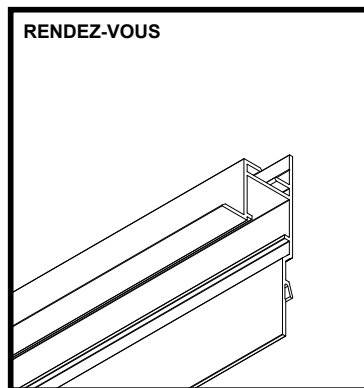
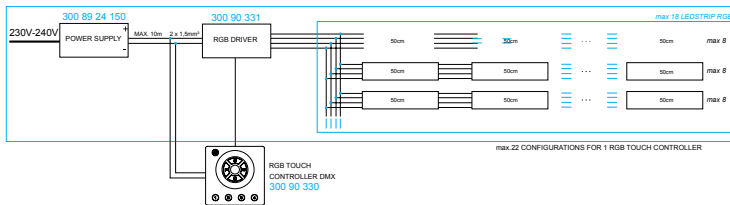

RV - PROFILE ANO
333 00 00 ANO

MAX. L / PROFILE : 6m
 ± 1,1 Kg / m

DELTA LIGHT
 Delta Light® nv.
 Muzelstraat 2
 B- 8560 Wevelgem (Moorsele)
 Belgium
 Phone: +32(0)56 435 735
 Fax: +32(0)56 435 738
 E-mail: info@deltaight.com
 www.deltaight.com

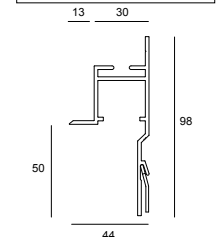
RENDEZ-VOUS - PROFILE

WAARSCHUWING Lees de algemene gebruiksvoorwaarden : **DEEL B**
AVERTISSEMENT Lire attentivement les conditions générales d'utilisation : **PARTIE B**
WARNING Lesen Sie die allgemeinen Gebrauchsanweisungen : **TEIL B**
WARNING Read the general directions : **PART B**
AMMONIZIONE Leggere attentamente le condizioni generali di utilizzazione : **PARTE B**
EDVERTENCIA Leer atentamente las condiciones generales de uso : **PARTE B**



6 RENDEZ-VOUS - CLEANING

CLEANING THE LUMINAIRE MUST BE SWITCHED-OFF AND COOL BEFORE BEING CLEANED.
 CLEANING OF LUMINAIRES: A DAMPENED SOFT CLOTH IS TO BE USED.
 CLEANING OF PLASTICS: USE A SOFT CLOTH AND A STANDARD pH-NEUTRAL, ALCOHOL FREE NON-SCOURING DETERGENT.
 CLEANING OF REFLECTORS: USE A SOFT CLOTH AND A STANDARD pH-NEUTRAL, ALCOHOL FREE NON-SCOURING DETERGENT.

Installeer het armatuur enkel in ruimten waar direct contact met water onmogelijk is.
 Cet équipement doit être installé dans des pièces hors de toute projection d'eau.
 Diese Leuchte darf nur in Räumen verwendet werden, in denen ein direkter Kontakt mit Wasser nicht möglich ist.
 This fitting should only be installed in rooms where direct contact with water is impossible.
 Este aparato solamente puede ser instalado en habitaciones donde el contacto directo con el agua sea imposible.
 Questo apparecchio di illuminazione deve essere installato solamente in locali in cui il contatto con l'acqua è impossibile.

Bevestiging wand inbouw
 Montage mur encastré
 Montage wand eingebaute
 Fixation wall recessed
 Montaje pared empotrado
 Montaggio parete incasso