

SUPERLOOP HC 120 MDL

DEEL
PARTIE
TEIL
PART
PARTE
PARTE **A**

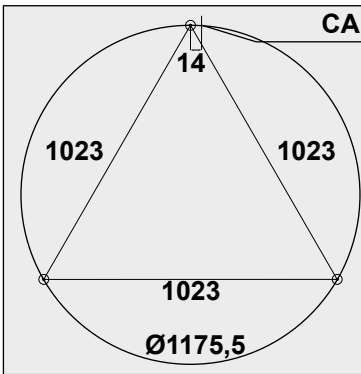
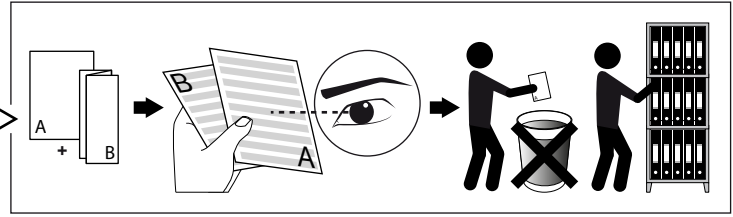
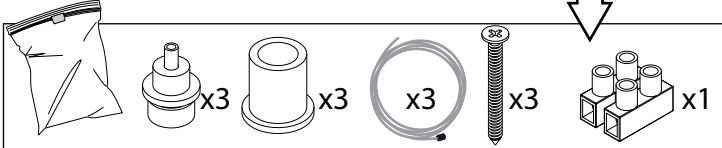
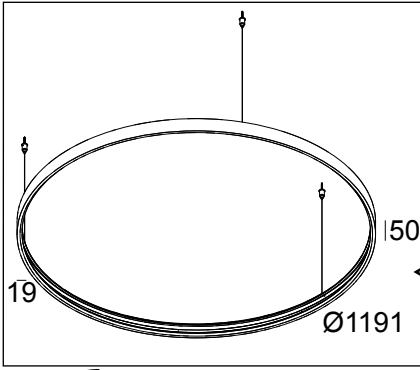

CABLE ENTRY

OPTIONS

CABLE BASE R	203 99 55	SUPERLOOP POWERBOX H 48V / 50W
CABLE BASE S	203 99 56	418 48 050
COVERSET R 100	204 00 100	SUPERLOOP POWERBOX L 48V / 100W
COVERSET R 90	204 00 90	418 48 100
COVERSET R 62	204 00 62	
COVERSET S 90	204 90 90	REQUIRED
COVERSET S 80	204 80 80	MIDISPY / SPY ON MDL (MAX 150W)
COVERSET S 62	204 62 62	418 26X XXX MDL
		LED POWER SUPPLY 48V-DC

Profile
Max 250W
LED
Max 150W
U 48V-DC

IP20
 Beschermtd tegen vaste voorwerpen die groter zijn dan 12 mm
 Protégé contre les objets solides de plus de 12 mm
 Geschützt gegen Festkörper größer als 12 mm
 Protected against solid objects greater than 12 mm
 Protegido contra objetos sólidos superiores a 12 mm
 Protetto contro oggetti solidi più grandi di 12 mm

III
 Enkel geschikt voor toestellen op zeer lage spanning (minder dan 50 V-AC / 120 V-DC)
 Convient uniquement pour les produits à très basse tension (moins de 50 V-AC / 120 V-DC)
 Geeignet für Güter mit sehr niedriger Spannung (unter 50 V-AC / 120 V-DC)
 Only suited for goods at very low voltage (below 50 V-AC / 120 V-DC)
 Se recomienda únicamente para aquellos productos de tensión muy baja (menos de 50 V-AC / 120 V-DC)
 Vale unicamente per i prodotti a tensione molto bassa (inferiore a 50 V-AC / 120 V-DC)

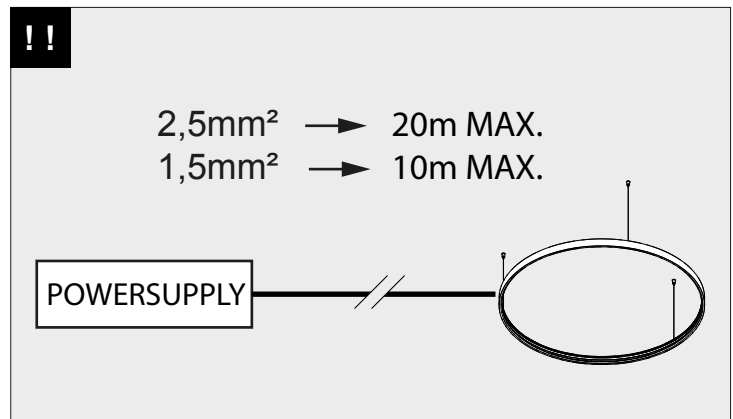
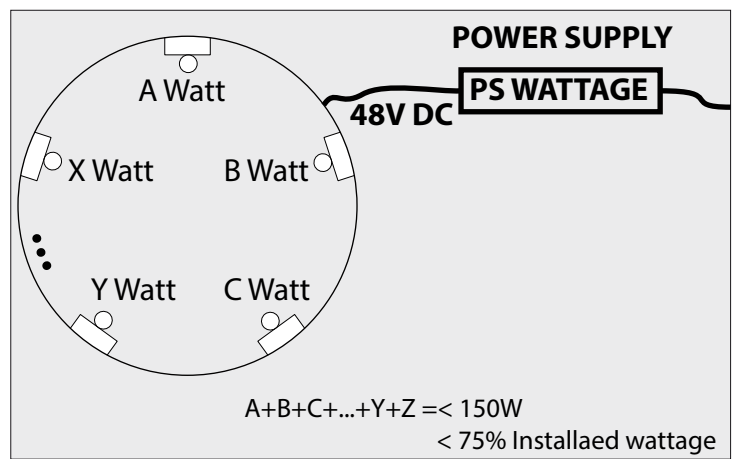
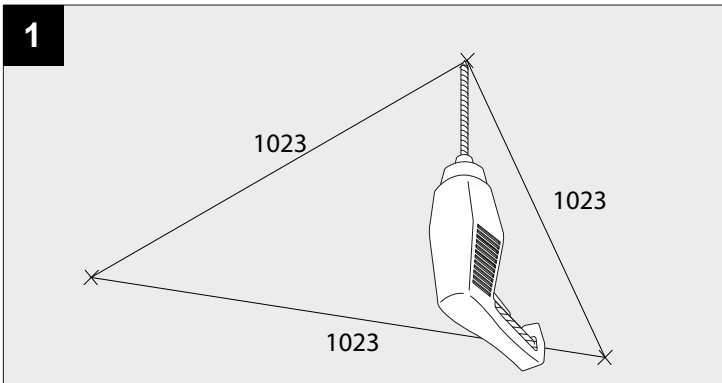

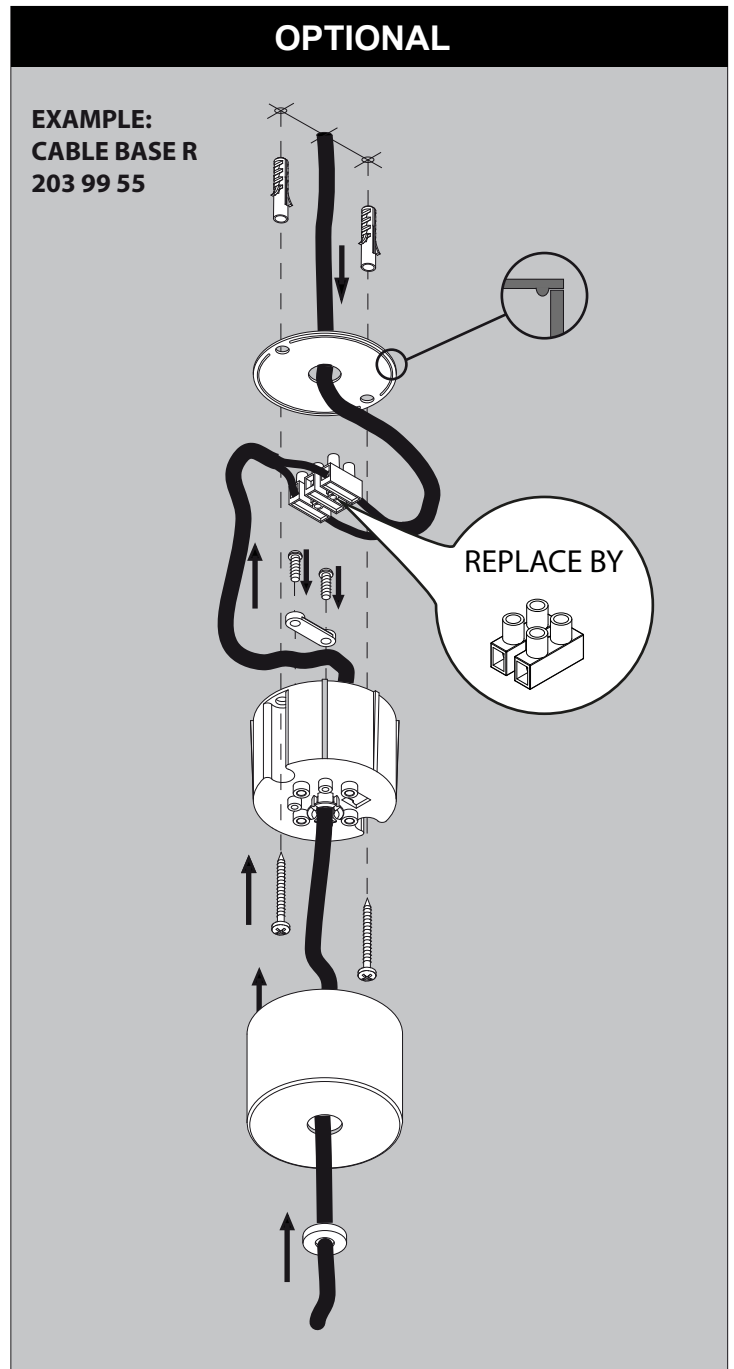
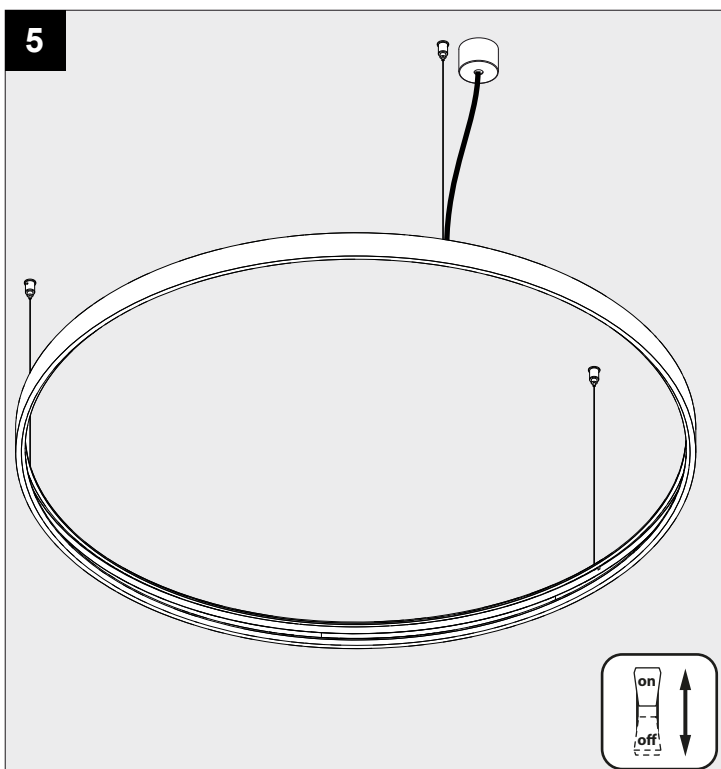
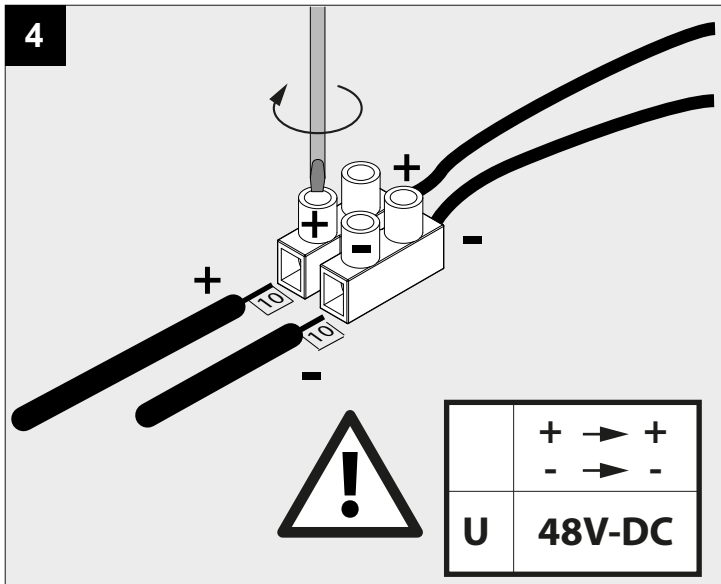
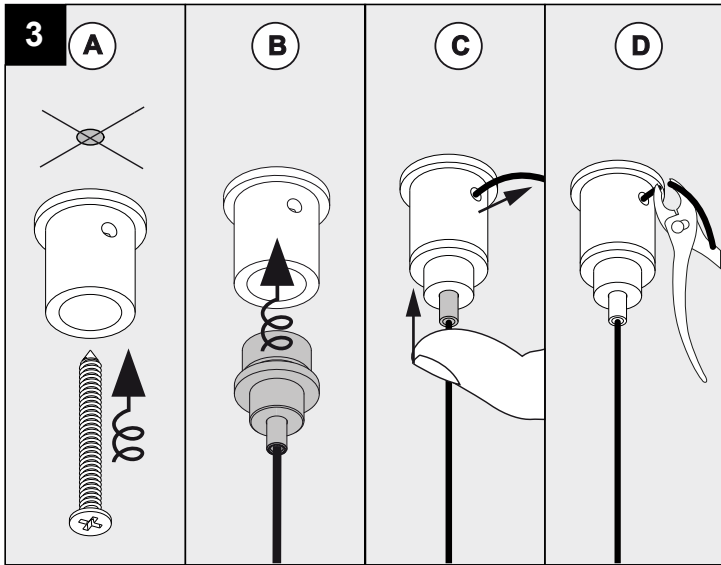

De verlichtingsbron van dit verlichtingstoestel zal enkel door de fabrikant of door de fabrikant aangestelde installateur vervangen worden.

La source lumière de cet appareil ne sera remplacée que par l'entreprise ou par un agent reconnu.

Das enthaltene Leuchtmittel sollte nur durch entsprechendes Fachpersonal ersetzt werden.

The light source contained in this luminaire shall only be replaced by the manufacturer or his service agent.

La fuente de iluminación que tiene esta luminaria sólo puede remplazarse por el fabricante o por un instalador autorizado.

La sorgente luminosa incorporata in questo apparecchio può essere sostituita solo dal produttore, da un suo centro assistenza oppure da una persona in possesso della necessaria abilitazione.