

DEEL  
PARTIE  
TEIL  
PART  
PARTE  
PARTE

**A**

**DOT.COM M4 TRIMLESS**

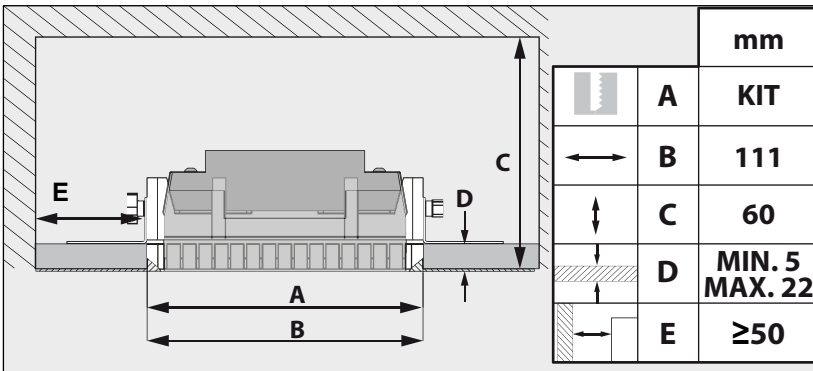
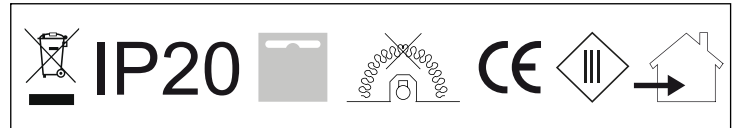
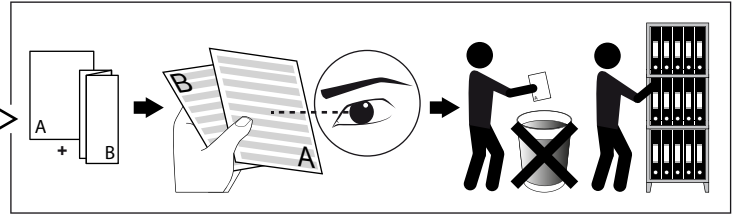
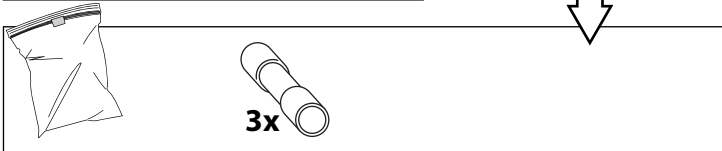
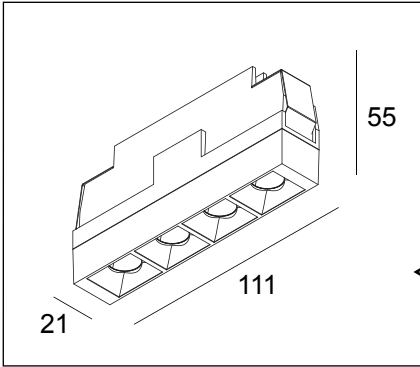

**REQUIRED  
MOUNTING KIT DOT.COM M4 TRIMLESS  
424 512 04 00**

<b>I<sub>i</sub></b>	<b>500mA</b>
<b>P</b>	<b>5,6W</b>
<b>U<sub>f</sub></b>	<b>11,6 V-DC</b>

**IP20**  
 Beschermtd tegen vaste voorwerpen die groter zijn dan 12 mm  
 Protégé contre les objets solides de plus de 12 mm  
 Geschützt gegen Festkörper größer als 12 mm  
 Protected against solid objects greater than 12 mm  
 Protegido contra objetos sólidos superiores a 12 mm  
 Protetto contro oggetti solidi più grandi di 12 mm

**III**  
 Enkel geschikt voor toestellen op zeer lage spanning (minder dan 50 V-AC / 120 V-DC)  
 Convient uniquement pour les produits à très basse tension (moins de 50 V-AC / 120 V-DC)  
 Geeignet für Güter mit sehr niedriger Spannung (unter 50 V-AC / 120 V-DC)  
 Only suited for goods at very low voltage (below 50 V-AC / 120 V-DC)  
 Se recomienda únicamente para aquellos productos de tensión muy baja (menos de 50 V-AC / 120 V-DC)  
 Vale unicamente per i prodotti a tensione molto bassa (inferiore a 50 V-AC / 120 V-DC)

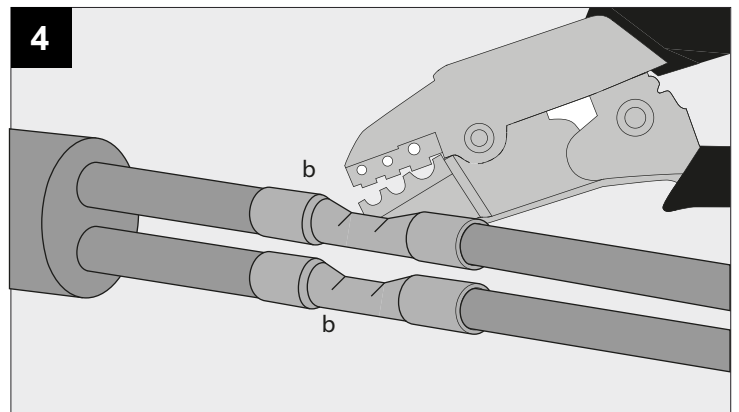
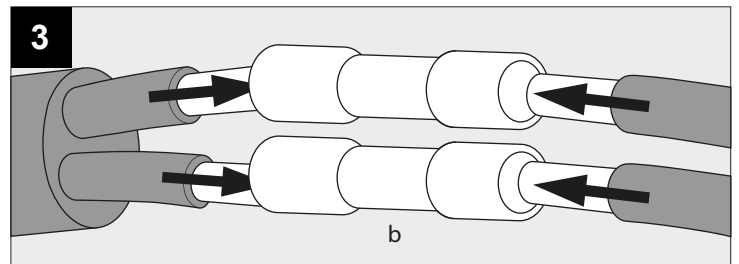
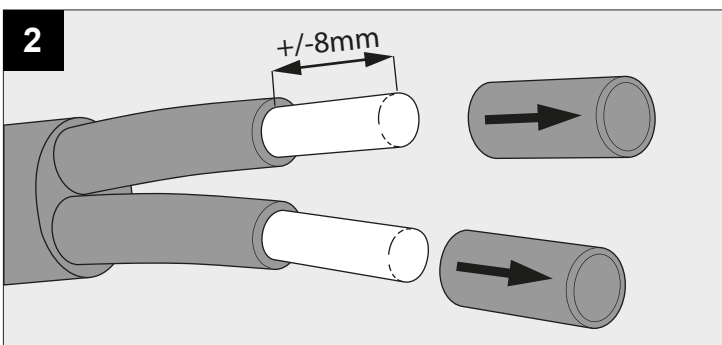
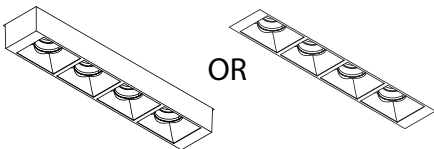

ELECTRICAL CONNECTION 

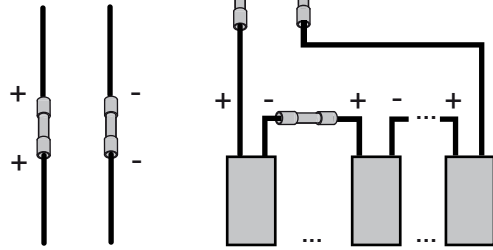

1 UNIT

>1 UNIT



**ATTENTION**  
OBSERVE PRECAUTIONS FOR  
HANDLING ELECTROSTATIC  
DISCHARGE SENSITIVE  
DEVICES

NO SECONDARY SWITCHING

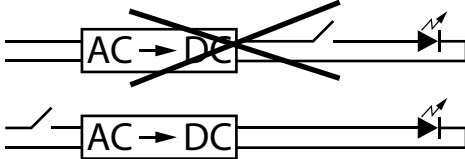

5

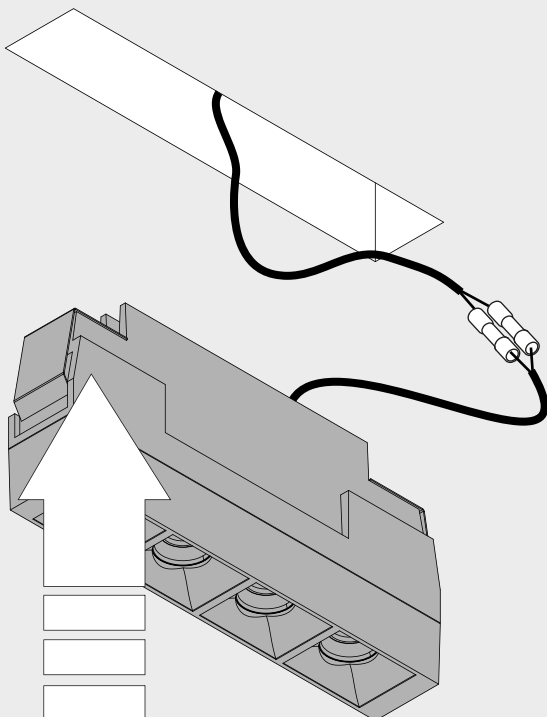

6

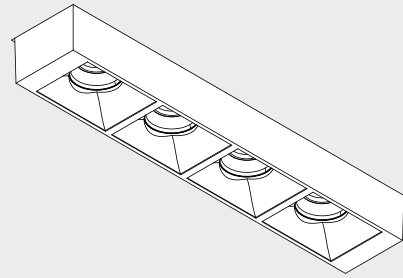

7

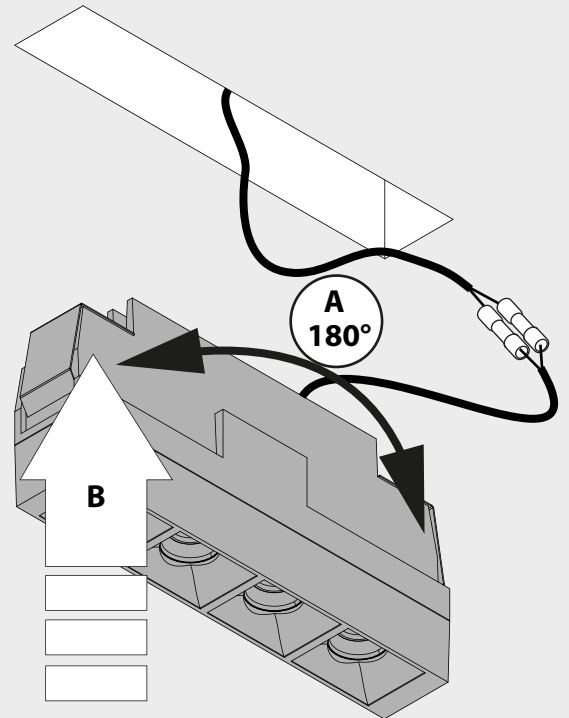

8

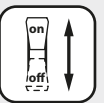
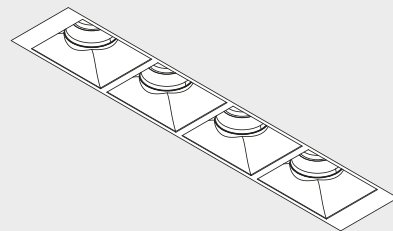

De verlichtingsbron van dit verlichtingstoestel zal enkel door de fabrikant of door de fabrikant aangestelde installateur vervangen worden.

La source lumière de cet appareil ne sera remplacée que par l'entrepreneur ou par un agent reconnu.

Das enthaltene Leuchtmittel sollte nur durch entsprechendes Fachpersonal ersetzt werden.

The light source contained in this luminaire shall only be replaced by the manufacturer or his service agent.

La fuente de iluminación que tiene esta luminaria sólo puede remplazarse por el fabricante o por un instalador autorizado.

La sorgente luminosa incorporata in questo apparecchio può essere sostituita solo dal produttore, da un suo centro assistenza oppure da una persona in possesso della necessaria abilitazione.